

# Service Manual

## Room Air Conditioner

**CS-G95KE CU-G95KE**  
**CS-G125KE CU-G125KE**



### **⚠ WARNING**

This service information is designed for experienced repair technicians only and is not designed for use by the general public. It does not contain warnings or cautions to advise non-technical individuals of potential dangers in attempting to service a product. Products powered by electricity should be serviced or repaired only by experienced professional technicians. Any attempt to service or repair the product or products dealt with in this service information by anyone else could result in serious injury or death.

### **⚠ PRECAUTION OF LOW TEMPERATURE**

In order to avoid frostbite, be assured of no refrigerant leakage during the installation or repairing of refrigeration circuit.

## CONTENTS

	Page		Page
1 Features .....	2	10 Installation Instructions .....	72
2 Functions .....	3	11 Servicing Information .....	81
3 Product Specifications .....	8	12 Technical Data .....	94
4 Dimensions .....	12	13 Exploded View .....	97
5 Refrigeration Cycle Diagram .....	14	14 Replacement Parts List .....	98
6 Block Diagram .....	15	15 Exploded View .....	99
7 Wiring Diagram .....	16	16 Replacement Parts List .....	100
8 Operation Details .....	18	17 Electronic Parts List .....	101
9 Operating Instructions .....	48	18 Electronic Circuit Diagram .....	103

# Panasonic

© 2000 Matsushita Air-Conditioning Corp. Sdn. Bhd. (183914D) All rights reserved. Unauthorized copying and distribution is a violation of law.

# 1 Features

## • Product

- Powerful Mode for quick cool/heat
- Compressor operating frequency control to maintain desired room temperature
- Automatic Restart after power failure
- Washable front panel
- Power Monitor Display
- Standby Control
- High COP (new compressor and indoor heat exchanger)
- Vertical and Horizontal Airflow Auto Swing
- Auto change over of Automatic Operation mode
- Self illuminating Remote Control
- Catechin Air Purifying Filter  
(To trap dust, tobacco smoke and tiny particles in the room; to prevent the growth of bacteria and viruses trapped in this filter)
- Deodorizing Filter

## • Serviceability

- Self diagnosis
- Forced Cooling and Heating operation at rated frequency

## • Quality Improvement

- High power supply voltage protection
- Low power supply voltage protection
- Gas leakage detection

## 2 Functions

### Remote Control



Self illuminating button

OFF / ON	<b>Operation OFF / ON</b>	TEMP.	<b>Room Temperature Setting</b>
	<b>Operation Mode Selection</b>	TIMER ON OFF	<b>Timer Operation Selection</b>
	<ul style="list-style-type: none"> <li><b>AUTO</b> Automatic Operation Mode</li> <li>HEAT Heating Operation Mode</li> <li>COOL Cooling Operation Mode</li> <li>DRY Soft Dry Operation Mode</li> <li>FAN Fan Operation Mode</li> </ul>	∨ ∧	<b>Time / Timer Setting</b>
POWERFUL	<b>Powerful Mode Operation</b>	SET CANCEL	<b>Timer Operation Set / Cancel</b>
FAN SPEED	<b>Indoor Fan Speed Selection</b>	CLOCK	<b>Clock Setting</b>
	<ul style="list-style-type: none"> <li> Low</li> <li> Medium-</li> <li> Medium</li> <li> Medium+</li> <li> High</li> <li>AUTO FAN Automatic Fan Speed</li> </ul>	SLEEP	<b>Sleep Mode Operation OFF / ON</b>
	<b>Airflow Direction Control</b>	WIDE / SPOT	<b>WIDE / SPOT</b>
	<ul style="list-style-type: none"> <li>Vertical Airflow Direction Control                             <ul style="list-style-type: none"> <li> AUTO Automatic Control</li> <li> Manual Control</li> </ul> </li> <li>Horizontal Airflow Direction Control                             <ul style="list-style-type: none"> <li> AUTO Automatic Control</li> <li> Manual Control</li> </ul> </li> </ul>		<ul style="list-style-type: none"> <li> WIDE Horizontal Airflow Direction</li> <li> SPOT Horizontal Airflow Direction</li> </ul>

## Indoor Unit



### FOR ALL OPERATIONS

AUTO  
OFF / ON

#### Automatic Switch

- Press for < 5s to operate Automatic Operation Mode.  
(Used when the remote control cannot be used.)
- Press continuously for 5s or < 8s to operate Forced Cooling Operation at compressor rated frequency:  
50 Hz (CS-G95KE); 70 Hz (CS-G125KE)
- Press continuously for 8s or < 11s to operate Forced Heating Operation at compressor rated frequency:  
71 Hz (CS-G95KE); 90 Hz (CS-G125KE)
- Press continuously for 11s or < 16s to switch over Remote Control A↔B Switch Signal.
- Press continuously for 16s or < 21s to switch OFF / ON Remote Control Receiving Sound and H14 Abnormality Detection Mode.

#### Operation Indication Lamps (LED)

- POWER (Green) ..... Lights up in operation, blinks in Automatic Operation Mode judging and Hot Start operation.
- TIMER (Orange) ..... Lights up in Timer Setting. Blinks in Self Diagnosis Control.
- SLEEP (Orange) ..... Lights up in Sleep Mode Operation.
- POWERFUL (Orange) .. Lights up when Powerful Mode is selected.

#### Power Monitor Display ✕

- Lights up during compressor operation.

#### Operation Mode

- Automatic, Heating, Cooling, Soft Dry and Fan Operation.

#### Automatic Restart Control ✕

- Operation is restarted after power failure at previous setting mode.

#### Sleep Operation Mode ✕

#### Timer Operation ✕

#### Powerful Mode ✕

- For quick cooling or heating.

#### Indoor Fan Speed Control ✕

#### Airflow Direction Control ✕

**COOLING / SOFT DRY OPERATION**

**Room Temperature Control ✕**

Operation Mode	Compressor Operation Frequency	
	CS-G95KE	CS-G125KE
Cooling	15 – 64 Hz	15 – 92 Hz
Soft Dry	15 – 22 Hz	15 – 22 Hz
Heating	15 – 99 Hz	15 – 115 Hz

**Temperature Shift ✕**

**Self Diagnosis ✕**

**Low Pressure Control ✕  
(Gas Leakage Detection)**

**Low / High Power Supply Voltage  
Protection ✕**

**Indoor Power Relay Control ✕**

**Deodorizing Control ✕**

**Sensible Heat Control ✕**

**Anti-Fog Discharge Control ✕**

**Anti-Dew Formation Control ✕**

**Anti Freezing Control ✕**

**Quiet Operation ✕**

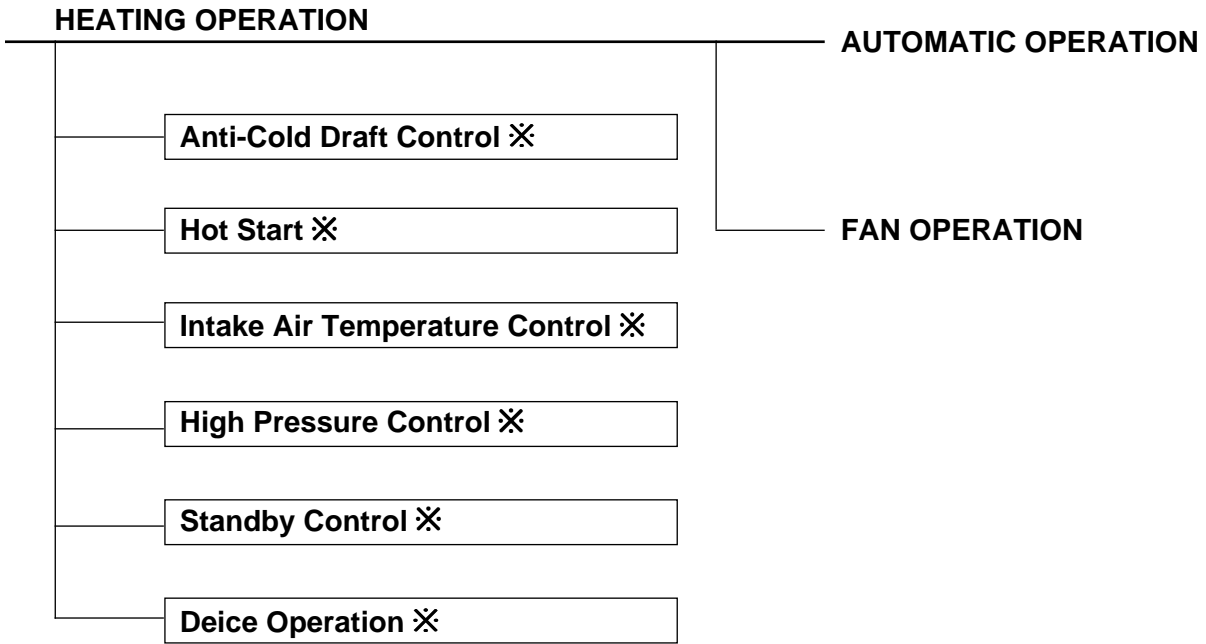

## Outdoor Unit



### Outdoor Fan Motor

- 6 poles induction motor, 1 speed.

### Time Delay Safety Control ✕

### Forced Operation 30 seconds ✕

### High Pressure Control ✕ (For Cooling / Soft Dry)

### DC Peak ✕

### Total Running Current Control ✕

### Compressor Overheating Protection ✕

### IPM (Power Transistor) Overheating Protection ✕

### Low Frequency Operation Protection ✕

### Minimum Frequency Operation Protection ✕

### Outdoor Air Temperature Control ✕



- Detect outdoor ambient temperature and limits compressor operating frequency.

### Standby Control ✕

### Deice Operation ✕

✕ Details can be referred to OPERATION DETAILS in this manual.

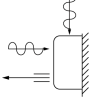
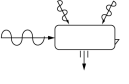

### 3 Product Specifications

		Unit	CS-G95KE	CU-G125KE
Cooling Capacity		kW kcal/h	2.6 (0.70 - 3.00) 2,240 (600 - 2,580)	
Heating Capacity		kW kcal/h	3.6 (0.63 - 5.00) 3,100 (540 - 4,300)	
Moisture Removal		l/h Pint/h	1.6 3.4	
Power Source		Phase V Cycle	Single 230 50	
Airflow Method		OUTLET  INTAKE 	SIDE VIEW 	TOP VIEW 
Air Volume	Indoor Air (Lo)	m <sup>3</sup> /min (cfm)	Cooling; 7.0 (250) Heating; 7.3 (260)	—
	Indoor Air (Me)	m <sup>3</sup> /min (cfm)	Cooling; 8.8 (310) Heating; 8.8 (310)	—
	Indoor Air (Hi)	m <sup>3</sup> /min (cfm)	Cooling; 10.0 (350) Heating; 10.0 (350)	—
	Outdoor Air	m <sup>3</sup> /min (cfm)	—	34.1 (1200)
Noise Level		dB (A)	Cooling; High 38, Low 26 Heating; High 39, Low 30	Cooling; 46 Heating; 47
		Power level dB	Cooling; High 51 Heating; High 52	Cooling; High 61 Heating; High 62
Electrical Data	Input	kW	Cooling; 0.73 (0.21 - 0.99) Heating; 0.99 (0.20 - 1.40)	
	Running Current	A	Cooling; 3.75 (max. 6.76) Heating; 4.80 (max. 6.76)	
	EER	W/W (kcal/hw)	Cooling; 3.56 (3.07)	
	COP	W/W (kcal/hw)	Heating; 3.64 (3.13)	
	Starting Current	A	4.80	
Piping Connection Port (Flare piping)		inch inch	G ; Half Union 3/8" L ; Half Union 1/4"	G ; 3-way valve 3/8" L ; 2-way valve 1/4"
Pipe Size (Flare piping)		inch inch	G (gas side) ; 3/8" L (liquid side) ; 1/4"	G (gas side) ; 3/8" L (liquid side) ; 1/4"
Drain Hose	Inner diameter	mm	12	—
	Length	m	0.7	—
Power Cord Length			2.1 m	—
Number of core-wire			3 core wires x 1.0 mm <sup>2</sup>	—



Dimensions	Height	inch (mm)	10 - 31/32 (279)	21 - 9/32 (540)	
	Width	inch (mm)	31 - 15/32 (799)	27 - 17/32 (699)	
	Depth	inch (mm)	7 - 27/32 (199)	11 - 7/32 (285)	
Net Weight		lb (kg)	20 (9.0)	86 (39)	
Compressor	Type		—	Rotary (2 cylinders) rolling piston type	
	Motor Type		—	Induction (4-poles)	
	Rated Output	W	—	500	
Air Circulation	Type		Cross-flow Fan	Propeller Fan	
	Material		AS + Glass Fiber 30%	P.P + (Mica + Glass Fiber) 30%	
	Motor Type		Transistor (4-poles)	Induction (6-poles)	
	Input	W	—	64	
	Rate Output	W	20	20	
	Fan Speed	Lo (Cool/Heat)	rpm	980 / 1,010	—
		Me (Cool/Heat)	rpm	1,160 / 1,220	—
Hi (Cool/Heat)		rpm	1,280 / 1,380	760	
Heat Exchanger	Description		Evaporator	Condenser	
	Tube material		Copper	Copper	
	Fin material		Aluminium	Aluminium	
	Fin Type		Slit Fin	Corrugated Fin	
	Row / Stage		(Plate fin configuration, forced draft)		
			2 / 14	1 / 20	
	FPI		21	19	
Size (W x H x L)	mm	614 x 294 x 25.4	782.9 x 508 x 22		
Refrigerant Control Device			—	Capillary Tube	
Refrigeration Oil		(c.c)	—	SUNISO 4GDID or ATMOS M60 (350)	
Refrigerant (R-22)		g (oz)	—	780 (27.5)	
Thermostat			Electronic Control	—	
Protection Device			Electronic Control	Electronic Control	
Capillary Tube	Length	mm	—	C1, C2 ; 1033, C3 ; 400	
	Flow Rate	l/min	—	C1, C2 ; 4.8, C3 ; 23.6	
	Inner Diameter	mm	—	C1, C2 ; 1.2, C3 ; 1.8	
Air Filter	Material Style		P.P. Honeycomb	—	
Fan Motor Capacitor		μF, VAC	—	2.0 μF, 400 VAC	

- Specifications are subject to change without notice for further improvement.

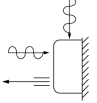
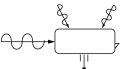
		Unit	CS-G125KE	CU-G125KE
Cooling Capacity		kW kcal/h	3.45 (0.74 - 4.00) 2,970 (640 - 3,440)	
Heating Capacity		kW kcal/h	4.80 (0.70 - 6.50) 4,130 (600 - 5,590)	
Moisture Removal		l/h Pint/h	2.0 4.2	
Power Source		Phase V Cycle	Single 230 50	
Airflow Method		OUTLET  INTAKE 	SIDE VIEW 	TOP VIEW 
Air Volume	Indoor Air (Lo)	m <sup>3</sup> /min (cfm)	Cooling; 9.0 (320) Heating; 9.1 (320)	—
	Indoor Air (Me)	m <sup>3</sup> /min (cfm)	Cooling; 10.4 (370) Heating; 10.3 (360)	—
	Indoor Air (Hi)	m <sup>3</sup> /min (cfm)	Cooling; 11.2 (400) Heating; 11.2 (400)	—
	Outdoor Air	m <sup>3</sup> /min (cfm)	—	31.5 (1110)
Noise Level		dB (A)	Cooling; High 41, Low 29 Heating; High 41, Low 35	Cooling; 48 Heating; 50
		Power level dB	Cooling; High 54 Heating; High 54	Cooling; High 63 Heating; High 65
Electrical Data	Input	kW	Cooling; 1.05 (0.22 - 1.33) Heating; 1.41 (0.22 - 2.00)	
	Running Current	A	Cooling; 5.00 (max. 8.96) Heating; 6.30 (max. 8.96)	
	EER	W/W (kcal/hw)	Cooling; 3.29 (2.83)	
	COP	W/W (kcal/hw)	Heating; 3.40 (2.93)	
	Starting Current	A	6.3	
Piping Connection Port (Flare piping)		inch inch	G ; Half Union 1/2" L ; Half Union 1/4"	G ; 3-way valve 1/2" L ; 2-way valve 1/4"
Pipe Size (Flare piping)		inch inch	G (gas side) ; 1/2" L (liquid side) ; 1/4"	G (gas side) ; 1/2" L (liquid side) ; 1/4"
Drain Hose	Inner diameter	mm	12	
	Length	m	0.7	
Power Cord Length			2.1 m	
Number of core-wire			3 core wires x 1.5 mm <sup>2</sup>	



# 4 Dimensions

## CS-G95KE / CS-G125KE

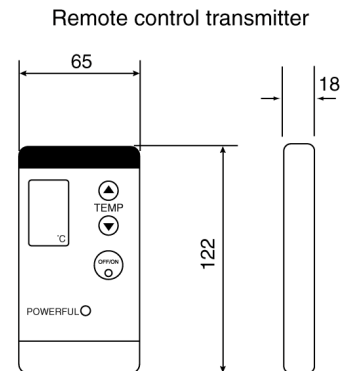
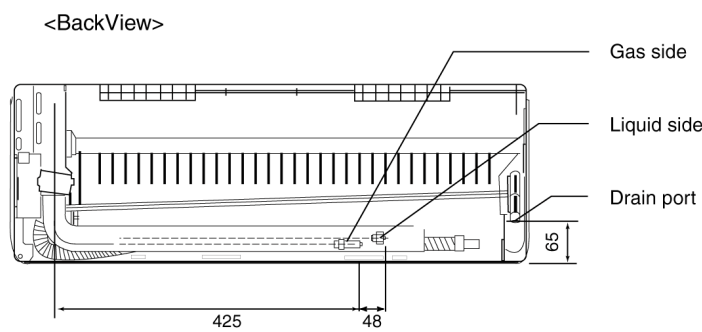
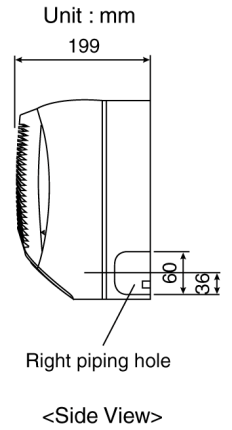
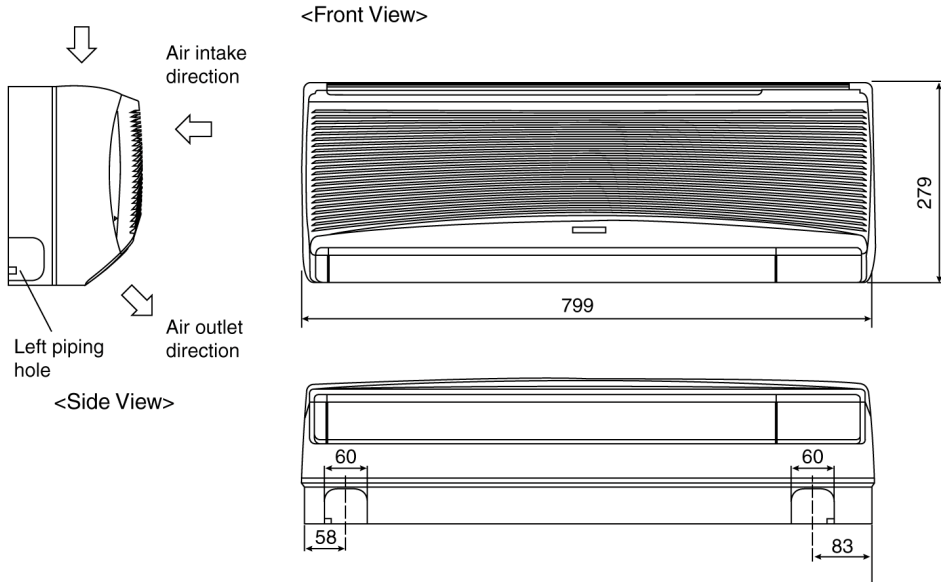

Relative position between the indoor unit and the installation plate <Front View>

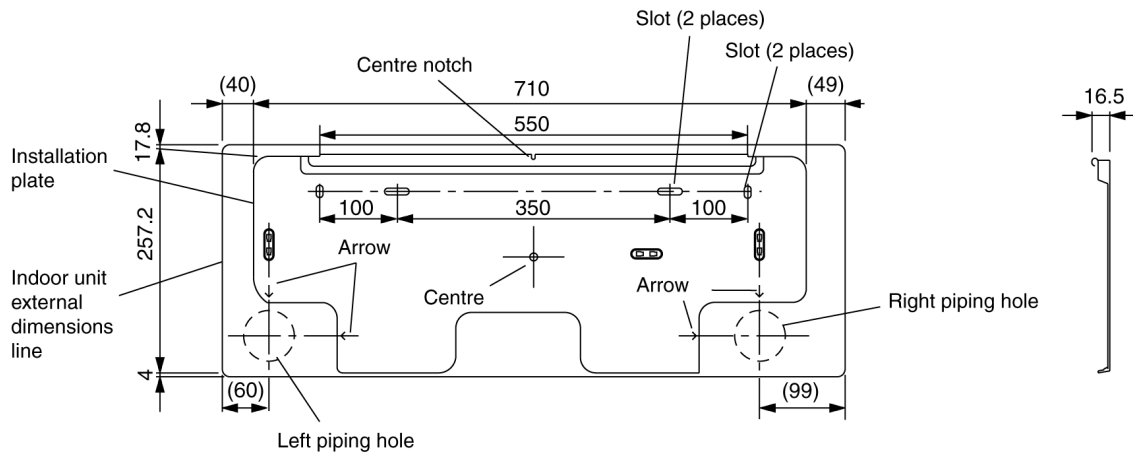

# CU-G95KE / CU-G125KE

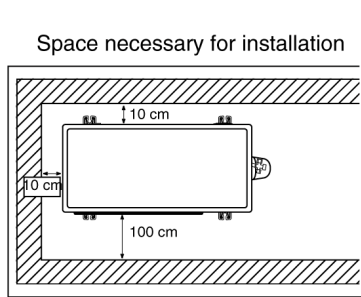

Anchor Bolt Pitch  
315 x 500

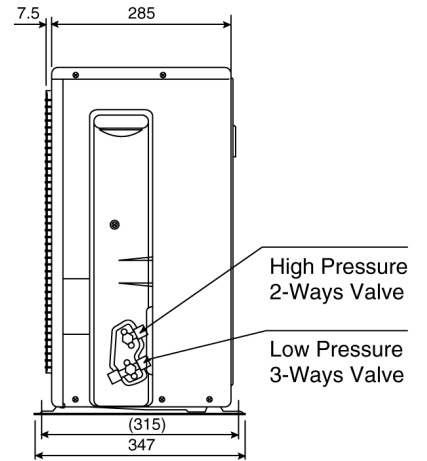
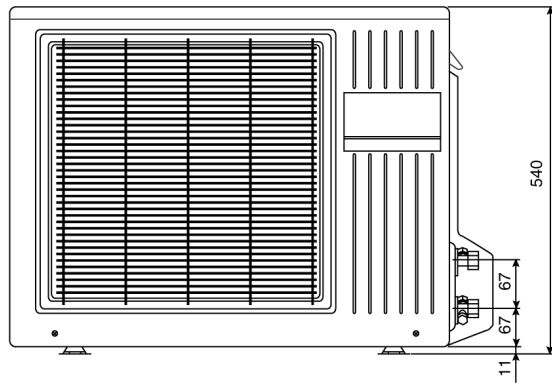
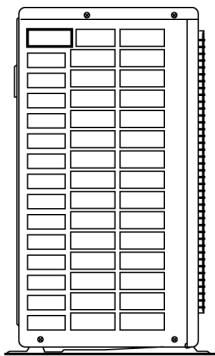
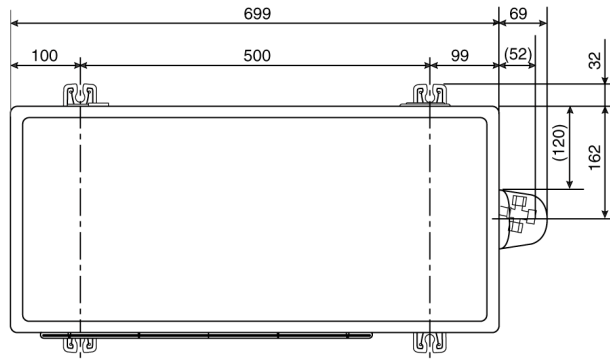

# 5 Refrigeration Cycle Diagram

CS-G95KE / CU-G95KE  
 CS-G125KE / CU-G125KE

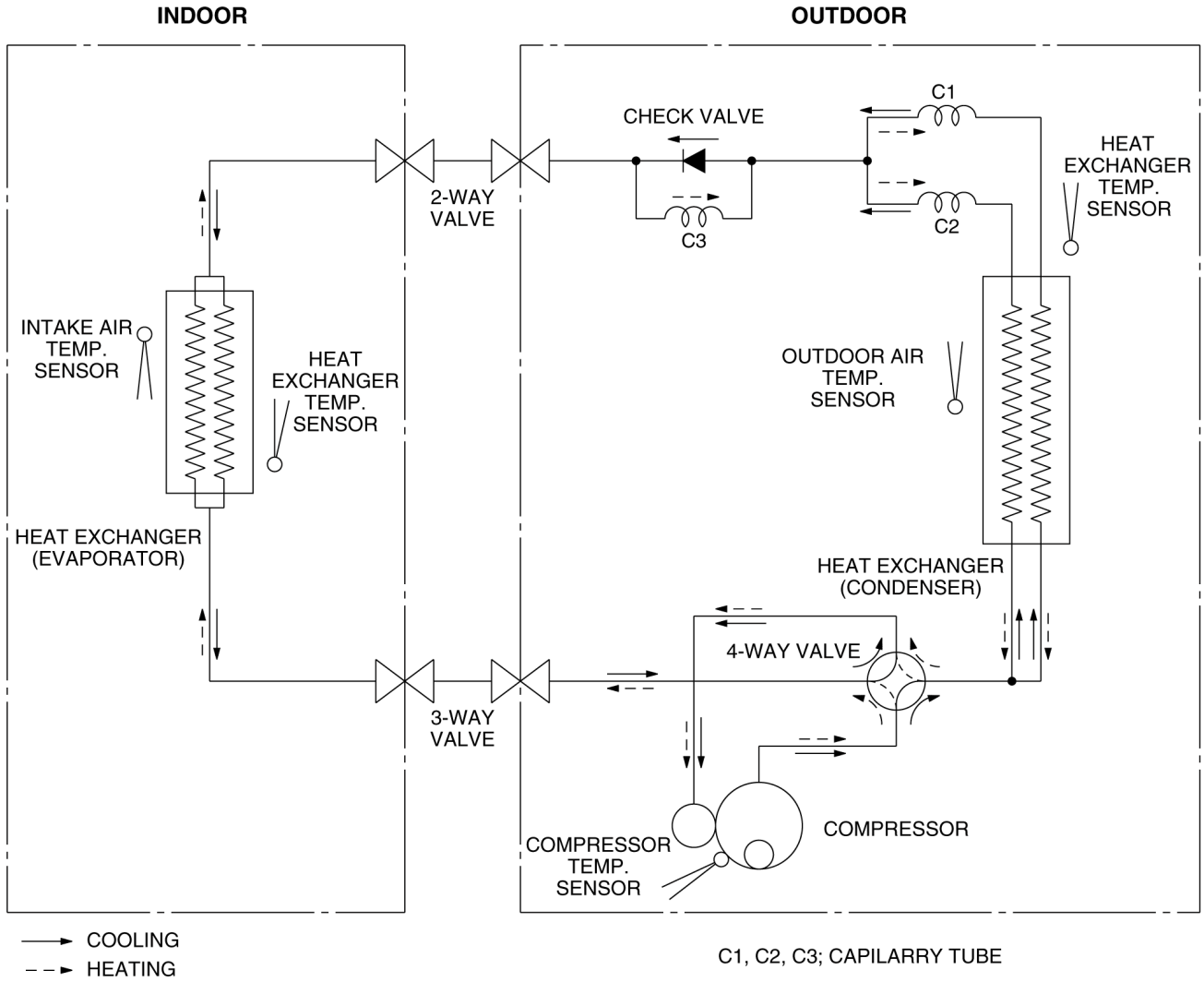

# 6 Block Diagram

CS-G95KE / CU-G95KE  
CS-G125KE / CU-G125KE

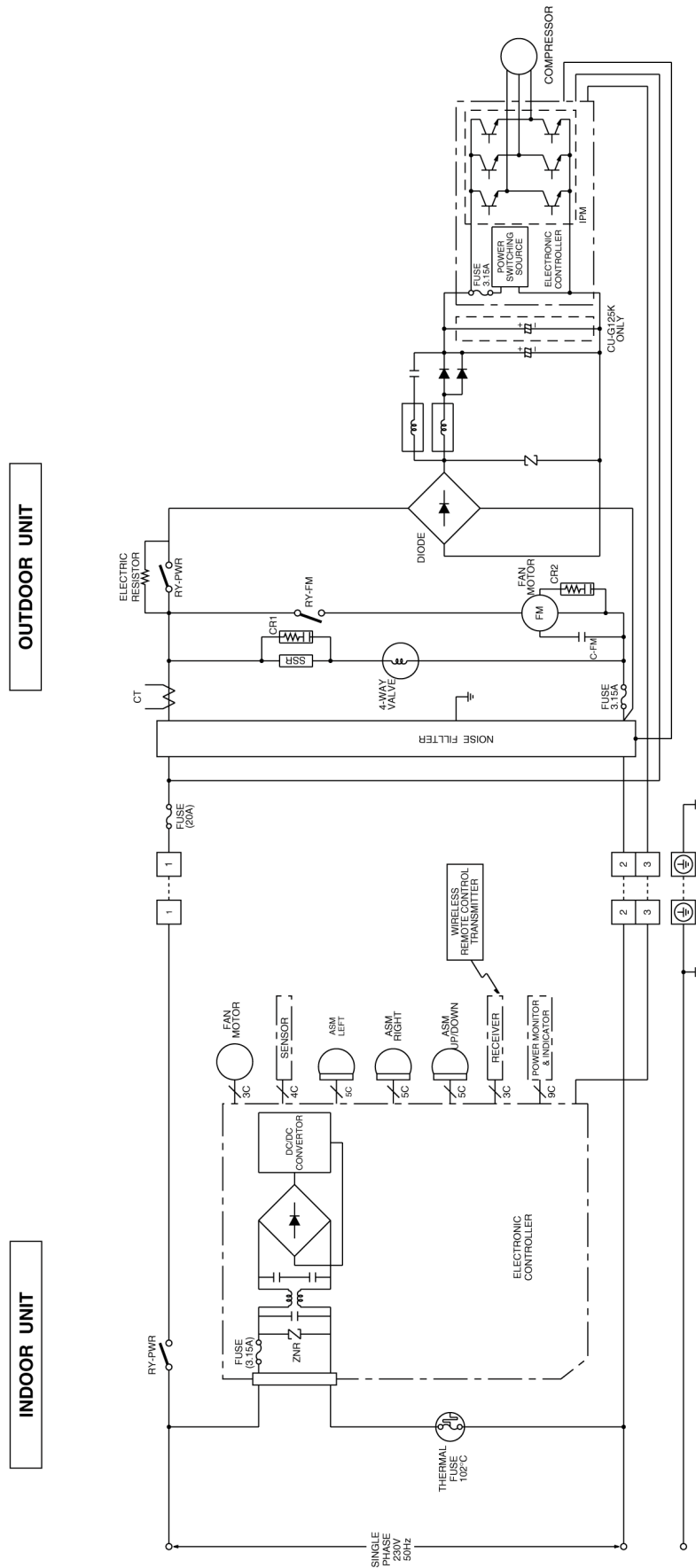







# 8 Operation Details

## 8.1. Function

### 1. Temperature Shift

Once the operation starts, the remote control setting temperature will be shifted internally based on the setting fan speed and outdoor air temperature. In addition, if Sleep Mode or Powerful Mode are set, the temperature shift will be carried out.

Setting of Internal Setting Temperature

The internal setting temperature can be decided as follows:

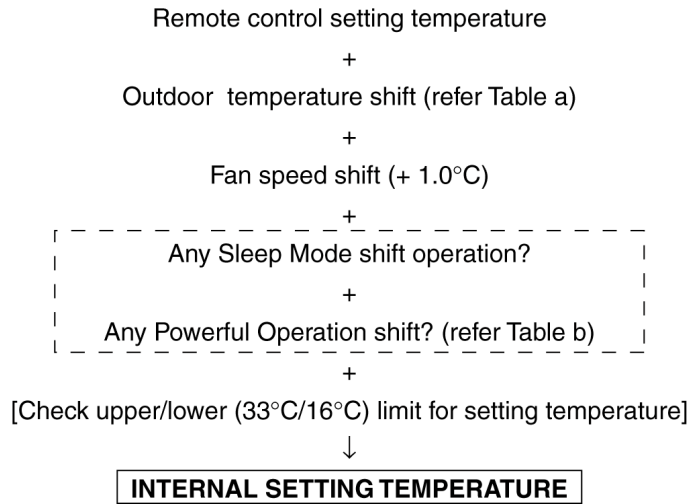

**Table a**

Setting Temperature Shift based on outdoor air temperature.

(i) Cooling, Soft Dry

	Shift amount	
	CS-G95KE	CS-G125KE
$38^\circ\text{C} \leq \text{Outdoor air temperature}$	-1.0°C	-1.0°C
$30^\circ\text{C} \leq \text{Outdoor air temperature} < 38^\circ\text{C}$	-0.5°C	-1.0°C
$23^\circ\text{C} \leq \text{Outdoor air temperature} < 30^\circ\text{C}$	0.0°C	0.0°C
Outdoor air temperature < 23°C	+1.0°C	+1.0°C

(i) Heating

	Shift amount
$21^\circ\text{C} \leq \text{Outdoor air temperature}$	-1.5°C
$17^\circ\text{C} \leq \text{Outdoor air temperature} < 21^\circ\text{C}$	-1.0°C
$13^\circ\text{C} \leq \text{Outdoor air temperature} < 17^\circ\text{C}$	-1.0°C
$9^\circ\text{C} \leq \text{Outdoor air temperature} < 13^\circ\text{C}$	0.0°C
$5^\circ\text{C} \leq \text{Outdoor air temperature} < 9^\circ\text{C}$	+0.5°C
$1^\circ \leq \text{Outdoor air temperature} < 5^\circ\text{C}$	+1.0°C
$-3^\circ\text{C} \leq \text{Outdoor air temperature} < 1^\circ\text{C}$	+1.0°C
Outdoor air temperature < -3°C	+1.5°C

**Table b**

Powerful Mode Shift.

	Cooling	Dry	Heating
Powerful	-4.0°C	-3.0°C	+6.0°C

## 2. Cooling Operation

### A. Room Temperature Control

(i) When the remote control setting temperature is less than 24°C

Cooling	Compressor Operation Frequency (Hz)				
Intake air temp. – Internal setting temp. (°C)	+1.5	64 (Fc max) or 50	64 (Fc max) or 50	92 (Fc max) or 70	92 (Fc max) or 70
	+1.0	36	40	44	49
	+0.5	31	31	31	31
Internal setting temp.	0	15	22	16	22
	-0.5	15	15	15	16
Compressor OFF temp.	-1.0	15	15	15	15
		Comp OFF	Comp OFF	Comp OFF	Comp OFF
Outdoor Air Temperature		Less than 38°C	38°C and above	Less than 38°C	38°C and above
Model No.		CS-G95KE		CS-G125KE	

(ii) When the remote control setting temperature is 24°C and above

Cooling	Compressor Operation Frequency (Hz)				
Intake air temp. – Internal setting temp. (°C)	+1.5	64 (Fc max) or 50	64 (Fc max) or 50	92 (Fc max) or 70	92 (Fc max) or 70
	+1.0	36	36	44	44
	+0.5	31	31	31	31
Internal setting temp.	0	15	15	16	16
	-0.5	15	15	15	15
Compressor OFF temp.	-1.0	15	15	15	15
		Comp OFF	Comp OFF	Comp OFF	Comp OFF
Outdoor Air Temperature		Less than 38°C	38°C and above	Less than 38°C	38°C and above
Model No.		CS-G95KE		CS-G125KE	

- Compressor OFF temperature = Compressor ON temperature.
- The operation frequency can be changed every 30 seconds.
- 30 minutes from the start of the operation, the compressor is operating at Fc max Hz.
- The compressor stops when the intake air temperature reaches 1°C below internal setting temperature and continues for 3 minutes.
- When the compressor stops, it will not begin operation for 3 minutes. (Time Delay Safety Control)
- When the intake air temperature reaches the Compressor ON temperature, the Compressor starts operation.
- When the compressor stops, the outdoor fan motor stops 30 seconds later.

**B. Deodorizing Control**

- This control is available during automatic fan speed for Cooling and Soft Dry Operation. It is not available during anti-freezing control.

Deodorizing Status	1	2	3	4	5	6	7	6, 7, 6, 7,...	1	
Compressor	ON			OFF						ON
Time (second)	40	50		30	60	30	60	.....	40	
Indoor Fan Speed	OFF	SLo	Auto	SLo	OFF	SLo	OFF	.....	OFF	

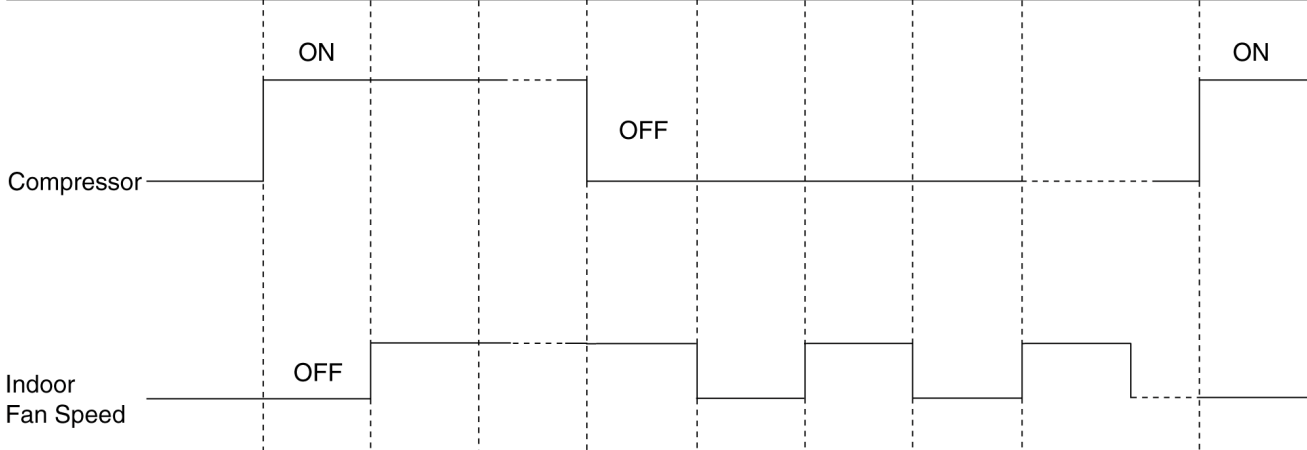

- When the compressor is in operation, the deodorizing status starts from 1 → 2 → 3.
- When the compressor stops operation, the deodorizing status starts from 4 → 5 → 6 → 7.
- If the compressor still stops operation after 3 minutes, the deodorizing status will start from 6.

**C. Sensible Heat Control**

- This control is to improve the feeling in high fan speed during low operation frequency. When the operation frequency is less than 33Hz (CU-G95KE) or 36Hz (CU-G125KE), the fan speed will reduce. When the operation frequency is increased to 40Hz (CU-G95KE) or 49Hz (CU-G125KE) continuously for 5 minutes, the fan speed will resume to normal condition.

**3. Soft Dry Operation**

**A. Room Temperature Control**

At the start of operation, cooling operation is running until the intake air temperature is 0.5°C higher than internal setting temperature, then the operation will shift to Soft Dry with indoor fan speed SLo.

Soft Dry	Compressor Operation Frequency (Hz)			
Intake air temp. – Internal setting temp. (°C)	Cooling Operation		Cooling Operation	
+1.5		22		22
+1.0		22		22
+0.5		15		16
Internal setting temp.	15	15	16	16
0	15	15	15	15
-0.5		15		15
Compressor OFF temp.	15	15	15	15
-3.5				
	Comp OFF	Comp OFF	Comp OFF	Comp OFF
Condition	When the temperature falls	When the temperature rises	When the temperature falls	When the temperature rises
Model No.	CS-G95KE		CS-G125KE	

- Compressor OFF temperature = Compressor ON temperature.
- The operation frequency changes every 30 seconds.
- 30 minutes from the start of the operation, the compressor is operating at Fc max Hz.
- The Compressor stops when the intake air temperature reaches 3.5°C below internal setting temperature and continues for 3 minutes.
- When the Compressor stops operation, indoor fan stops for 330 seconds.
- When the Compressor stops, it will not begin operation for 3 minutes. (Time Delay Safety Control)
- When the intake air temperature reaches the Compressor ON temperature, the Compressor starts operation immediately.
- When the Compressor stops, the outdoor fan motor stops 30 seconds later.

**B. Deodorizing Control**

- This control is available during automatic fan speed for Cooling and Soft Dry Operation. It is not available during anti-freezing control.

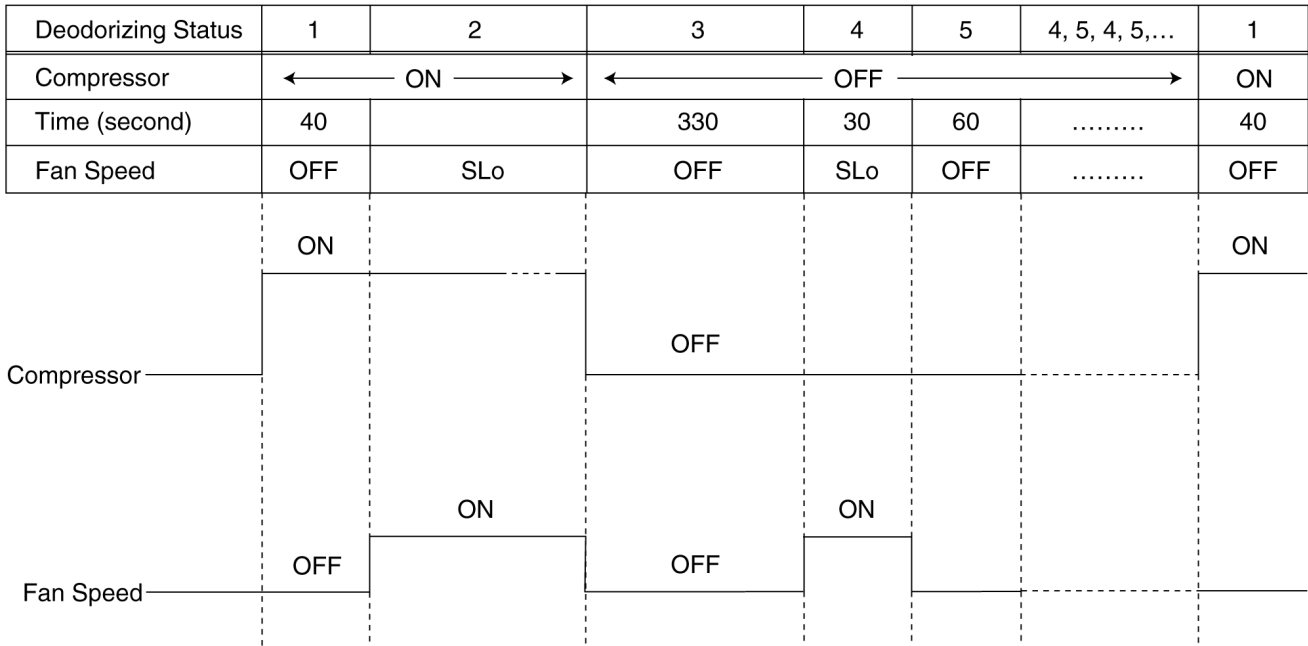

- When the compressor is in operation, the deodorizing status starts from 1 → 2.
- When the compressor stops operation, the deodorizing status starts from 3 → 4 → 5.
- If the compressor stops operation, indoor fan stops for 330 seconds.

**C. Sensible Heat Control**

- This control is to improve the feeling in high fan speed and low operation frequency. When the operation frequency is less than 33Hz (CU-G95KE) or 36Hz (CU-G125KE), the fan speed will reduce. When the operation frequency is increased to 40Hz (CU-C95KE) or 49Hz (CU-C125KE) continuously for 5 minutes, the fan speed will resume to normal condition. (During Cooling operation).

**4. Heating Operation**

**A. Room Temperature Control**

- During heating operation, the room temperature control depends on intake air temperature and internal setting temperature. Basically it can be divided into 2 periods as shown below:

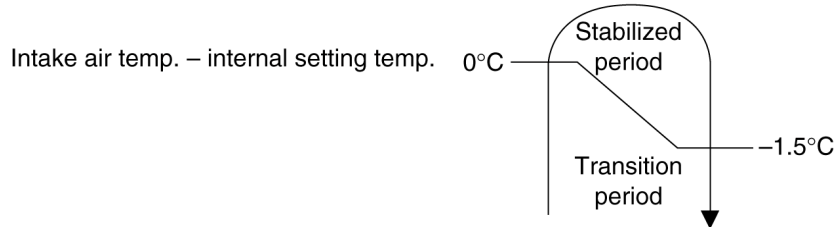

(i) When indoor fan speed is Medium or above.

**CS-G95KE**

Heating Operation	Compressor Operation Frequency (Hz)				
	Transition Period	Stabilized Period			
Remote Control Setting Temp.	16°C ~ 30°C	16°C ~ 20°C		21°C ~ 30°C	
Intake air temperature – Internal setting temperature	Comp Off	Comp Off	Comp Off	Comp Off	Comp Off
Compressor OFF	+1.5	15	15	15	15
	+1.0	15	15	26	15
	+0.5	22	22	33	22
Internal setting temp.	0	46	26	36	26
	-0.5	53	33	46	33
	-1.0	64	36	53	36
	-1.5	71 (Fh) or 99 (Fhmax)	71 (Fh) or 99 (Fhmax)	71 (Fh) or 99 (Fhmax)	71 (Fh) or 99 (Fhmax)
Outdoor air temperature		Less than -1°C	-1°C and above	Less than -1°C	-1°C and above

**CS-G125KE**

Heating Operation	Compressor Operation Frequency (Hz)					
	Transition Period	Stabilized Period				
Remote Control Setting Temp.	16°C ~ 30°C	16°C ~ 20°C		21°C ~ 30°C		
Intake air temperature – Internal setting temperature	Comp Off	Comp Off	Comp Off	Comp Off	Comp Off	
Compressor OFF  Internal setting temp.	+1.5	16	16	16	16	
	+1.0	16	16	16	27	
	+0.5	22	22	22	36	
	0	64	27	27	44	
	-0.5	74	36	36	64	
	-1.0	86	44	44	74	
	-1.5	90 (Fh) or 115 (Fhmax)	90 (Fh) or 115 (Fhmax)	90 (Fh) or 115 (Fhmax)	90 (Fh) or 115 (Fhmax)	90 (Fh) or 115 (Fhmax)
	Outdoor air temperature		Less than -1°C	-1°C and above	Less than -1°C	-1°C and above

(ii) When indoor fan speed is lower than Medium.

**CS-G95KE**

Heating Operation	Compressor Operation Frequency (Hz)					
	Transition Period	Stabilized Period				
Remote Control Setting Temp.	16°C ~ 30°C	16°C ~ 20°C		21°C ~ 30°C		
Intake air temperature – Internal setting temperature	Comp Off	Comp Off	Comp Off	Comp Off	Comp Off	
Compressor OFF  Internal setting temp.	+1.5	15	15	15	15	
	+1.0	15	22	22	26	
	+0.5	22	26	26	33	
	0	46	33	33	36	
	-0.5	53	36	36	46	
	-1.0	64	46	46	53	
	-1.5	71 (Fh) or 99 (Fhmax)	71 (Fh) or 99 (Fhmax)	71 (Fh) or 99 (Fhmax)	71 (Fh) or 99 (Fhmax)	71 (Fh) or 99 (Fhmax)
	Outdoor air temperature		Less than -1°C	-1°C and above	Less than -1°C	-1°C and above



## CS-G125KE

Heating Operation	Compressor Operation Frequency (Hz)				
	Transition Period	Stabilized Period			
Remote Control Setting Temp.	16°C ~ 30°C	16°C ~ 20°C		21°C ~ 30°C	
Intake air temperature – Internal setting temperature	Comp Off	Comp Off	Comp Off	Comp Off	Comp Off
Compressor OFF	+1.5	16	16	16	16
	+1.0	16	22	22	22
	+0.5	22	27	27	27
Internal setting temp.	0	64	36	36	36
	-0.5	74	44	44	44
	-1.0	86	64	64	64
	-1.5	90 (Fh) or 115 (Fhmax)	90 (Fh) or 115 (Fhmax)	90 (Fh) or 115 (Fhmax)	90 (Fh) or 115 (Fhmax)
Outdoor air temperature		Less than -1°C	-1°C and above	Less than -1°C	-1°C and above

- Compressor OFF temperature = compressor ON temperature.
- The operation frequency changes every 30 seconds.
- When the difference of the intake air temperature and Internal setting temperature is -1.5°C or more, compressor will operate at Fh continuously for 3 minutes and then change over to Fhmax.
- The compressor stops when the intake air temperature reaches 1.5°C above internal setting temperature and continues for 3 minutes.
- When the compressor stops, it will not start operation for 3 minutes. (Time Delay Safety Control)
- When the intake air temperature decreases to the compressor ON temperature, the compressor starts immediately.
- When the compressor stops, the outdoor fan motor stops 30 seconds later.

**B. Anti Cold Draft Control**

(i) Indoor Fan Control

Indoor fan speed and airflow direction varies in accordance to the indoor heat exchanger temperature as shown below:

(a) Manual Fan speed control

**(Auto Airflow Direction Control)**

**(Manual Airflow Direction Control)**

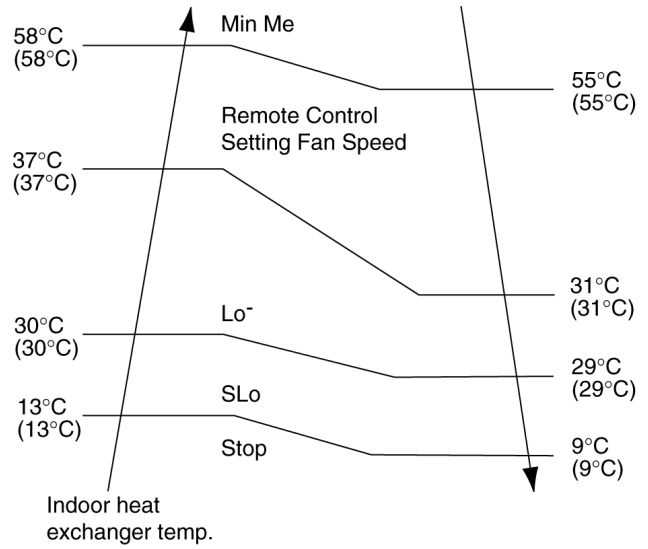
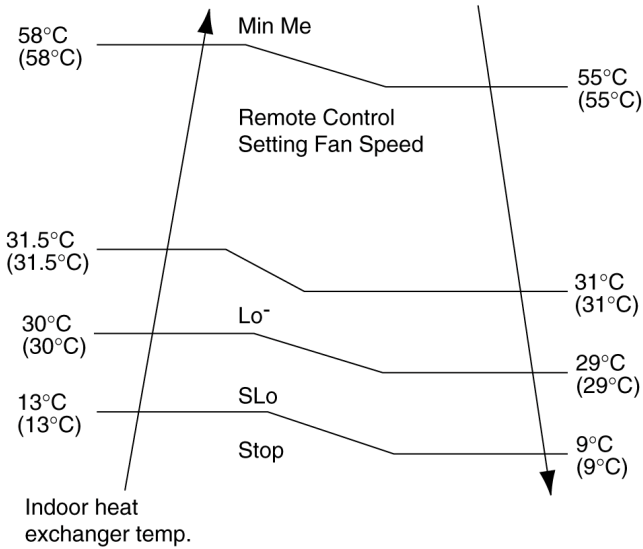

(b) Auto Fan speed control

**(Auto Airflow Direction Control)**

**(Manual Airflow Direction Control)**

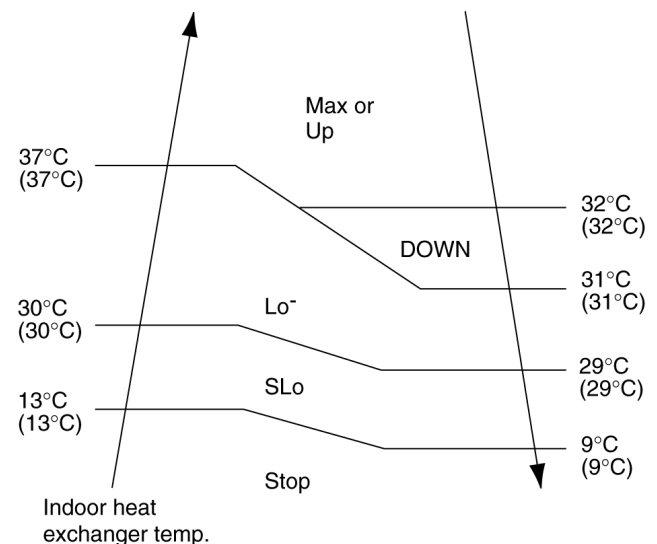
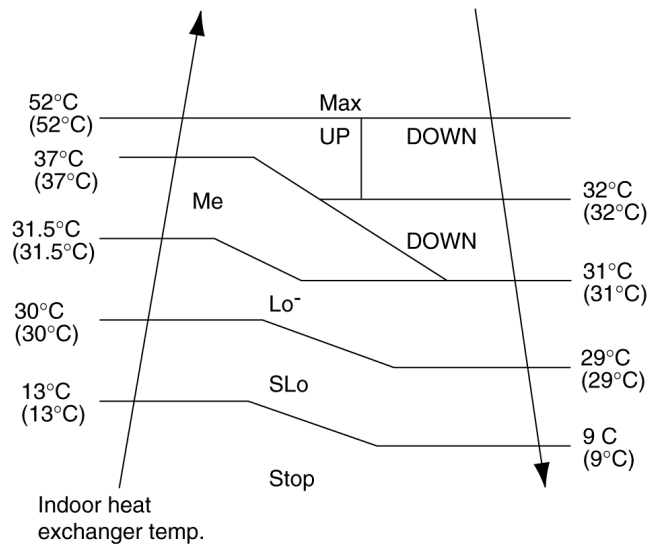

**Note:**

- UP means fan speed is increased by 1 rank.
- DOWN means fan speed is decreased by 1 rank.
- Max means fan speed is running at maximum auto fan speed.
- Temperature in ( ) is indicating when powerful mode is selected.

## (ii) Hot Start

- At the start of heating operation, the indoor fan stops and compressor operates at F<sub>max</sub> frequency 99Hz (CS-G95KE) or 115Hz (CS-G125KE). This is to heat up the indoor heat exchanger in order to avoid cold air discharged.
- Hot Start ends when
  - a. Indoor heat exchanger temperature reaches over 15°C
  - or
  - b. 4 minutes after heating operation starts.
- After Hot Start operation, compressor operates at F<sub>max</sub> 99Hz (CS-G95KE) or 115Hz (CS-G125KE) for 2 minutes.

## (iii) Vertical and Horizontal Airflow Direction Control

- Vertical and horizontal airflow direction control is in accordance to indoor heat exchanger temperature. The control is valid for automatic airflow direction only.

**C. Deice Operation**

Deice operation occurs when the deice operation starting signal is generated. This happens when one of the following conditions occurs. However, the first deice operation will begin 1 hour after start of heating operation.

	Outdoor Heat Exchanger Temp. $T_h < 3^\circ\text{C}$	Outdoor Heat Exchanger Temp. ( $T_h$ )	Outdoor Temp. ( $T_o$ )
Case 1	120 minutes continuously	$T_h < -6^\circ\text{C}$ for 3 min continuously	$T_o > -1^\circ\text{C}$
Case 2	80 minutes continuously	$T_h < -7^\circ\text{C}$ for 3 min continuously	$T_o > -1^\circ\text{C}$
Case 3	40 minutes continuously	$T_h < -9^\circ\text{C}$ for 3 min continuously	$T_o > -3^\circ\text{C}$
Case 4	40 minutes continuously	$T_h < -11^\circ\text{C}$ for 3 min continuously	$T_o > -3^\circ\text{C}$

**Note:** The above 4 cases are under compressor operating condition.

Deice Operation Time Chart

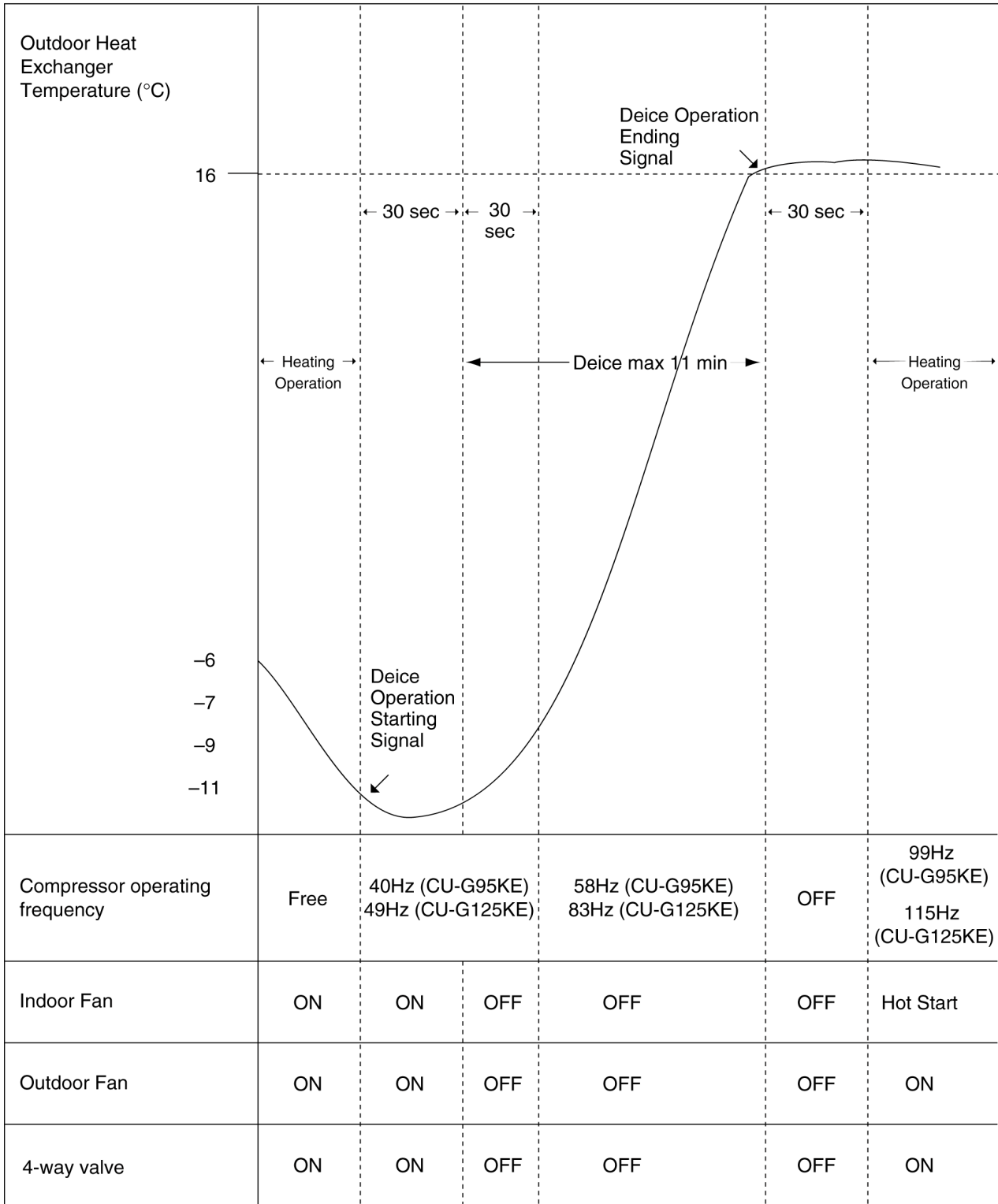

- Compressor frequency is set at 40Hz (CU-G95KE) or 49Hz (CU-G125KE) when the deice operation starting signal is generated.
- 30 seconds later deice operation starting signal is generated, indoor fan, outdoor fan, 4-way valve are turned off and compressor operates at 40Hz (CU-G95KE) or 49Hz (CU-G125KE) for 30 seconds. (Deice operation starts)
- During deice operation, the compressor operating frequency is set at 58Hz (CU-G95KE) or 83Hz (CU-G125KE).
- Deice will end when the outdoor heat exchanger temperature rises to 16°C or after 11 minutes.

**D. Standby Control**

(a) The purpose of Standby Control is to warm up the compressor when outdoor temperature is low. The standby control will be activated when all of the followings occur.

- (i) Main power is supplied.
- (ii) Unit is not operating.
- (iii) Outdoor ambient temperature is below 3°C.
- (iv) Compressor stops more than 3 hours.

(b) When the standby control is activated, low electricity will be supplied to compressor for 1 minute and stops for 4 minutes. This condition is repeated until standby control is cancelled. It will consume about 35 W of electric power.

Electricity supplied to compressor	ON	OFF	ON	OFF	.....
Time	1 min	4 min	1 min	4 min	.....

(c) Standby control will be cancelled when one of the following conditions occurs.

- (i) Unit starts operation.
- (ii) Outdoor ambient temperature  $\geq 5^{\circ}\text{C}$
- (iii) Compressor starts operation.
- (iv) Protection control is activated.

(b) When the unit is switched on by the remote control, the compressor operates at frequency as shown in below:-

	Frequency			
CS-G95KE	Max. 36Hz Min. 33Hz	Max. 36Hz	Max. 71Hz	Free
CS-G125KE	Max. 44Hz Min. 36Hz	Max. 44Hz	Max. 90Hz	Free
Time (sec)				

(e) Jumper (J2) at indoor electronic controller should be open circuit to cancel the standby control.

## 5. Fan Operation

This operation is enable the fan operation without compressor running. Timer operation is valid for fan operation.

## 6. Automatic Operation

When the Automatic mode is selected, the operation mode is decided in accordance to remote control setting temperature, intake air temperature and outdoor air temperature.

- During judging the operation mode, indoor fan is running at Lo speed and outdoor fan at ON in order to sense the indoor intake air temperature and outdoor air temperature for 20 seconds. At this time, Power LED is blinking.  
After the operation mode is selected, Power LED lights up.

Refer to the examples below, there are 4 determination charts when automatic mode is selected.

(a) When setting temperature of remote control is 18°C and below.

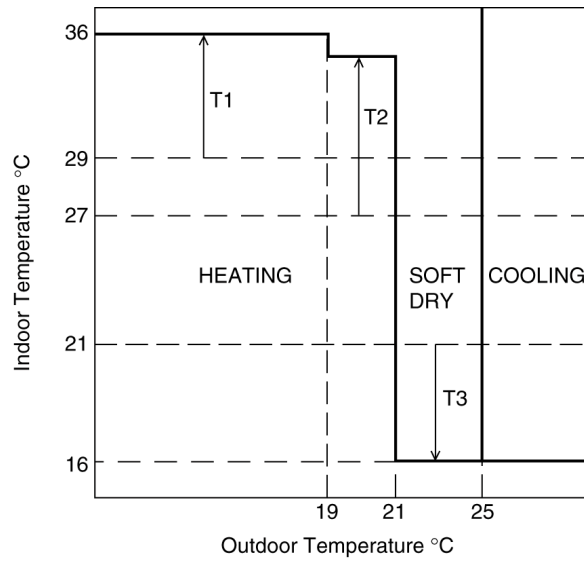

(b) When setting temperature of remote control is 19°C ~ 22°C.

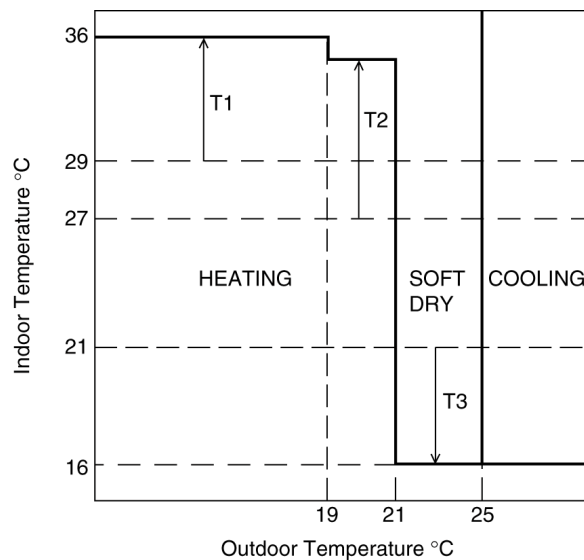

(c) When setting temperature of remote control is 23°C ~ 26°C.

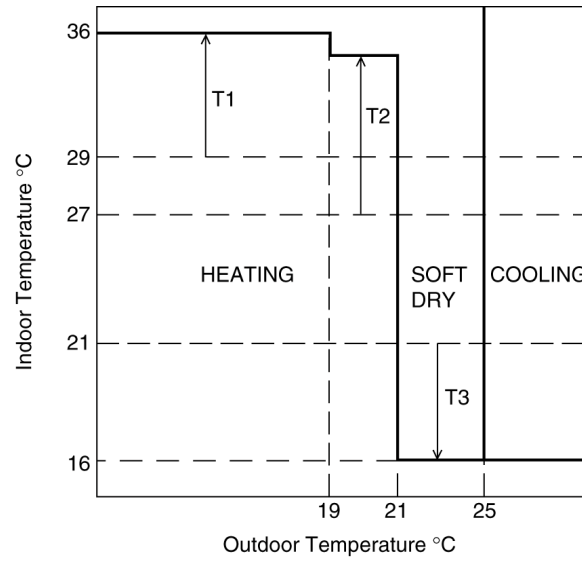

(d) When setting temperature of remote control is 27°C and above.

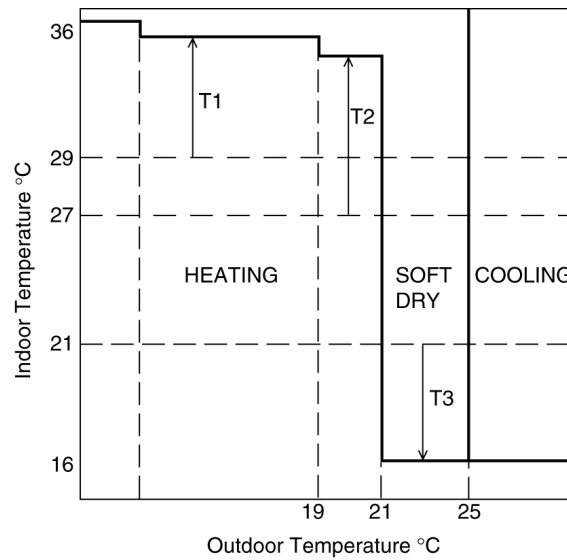

Setting Temp. °C	T1	T2	T3
18 and below	+10	+8	-5
19 - 22	+8	+7	-7
23 - 26	+7	+6	-7
27 and above	+6	+5	-8

**Note:** Base temperature for T1 is 29°C  
 Base temperature for T2 is 27°C  
 Base temperature for T3 is 21°C

- When the operation mode is changed over, the value for t1, t2 and t3 are shifted as below:  
 Cooling/Soft dry → Heating: - 2°C  
 Heating → Cooling/Soft dry: + 2°C
- When the indoor intake air temperature is lower than 16°C, heating operation is immediately started.
- When the outdoor air temperature is more than 25°C, and the intake air temperature is over 16°C, cooling operation is immediately started.
- The operation mode is judged every 30 minutes.
- When the operation mode (Heating, Cooling or Soft Dry) is decided, the internal setting temperature will shift as shown below:

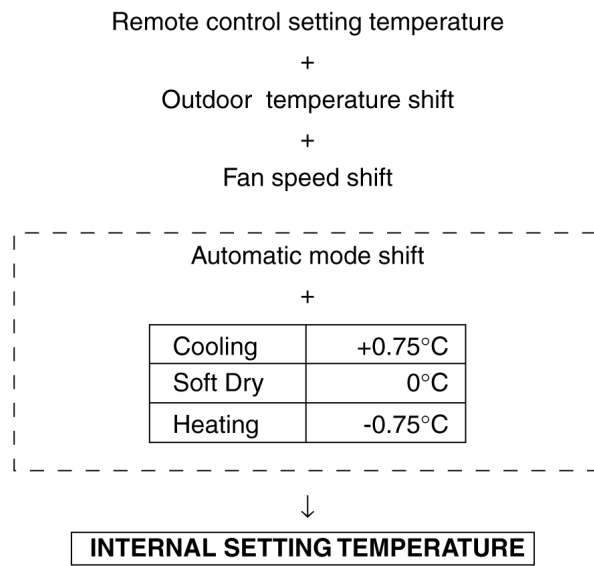



<b>7. Indoor Fan Speed Control</b>
------------------------------------

Fan Speed No.	Voltage Supply to DC (V) CS-G95KE	Voltage Supply to DC (V) CS-G125KE	Cooling		Soft Dry	Remarks	Heating		Remarks
			Manual	Auto			Manual	Auto	
0			OFF	OFF	OFF		OFF	OFF	• Hot Start Control
1									
2	15.6	16.3			SLo	<ul style="list-style-type: none"> <li>• Deodorizing control</li> <li>• Sleep Mode (Soft Dry)</li> </ul>			• SLo: Hot Start Control
3	16.3	17.6			Lo <sup>-</sup>	<ul style="list-style-type: none"> <li>• Auto operation mode judgement</li> <li>• Quiet operation</li> </ul>			
4	17.6	20.3							
5	17.9	21.7							• Lo <sup>-</sup> : Hot Start Control Sleep Mode Anti Cold Draft Control Thermo OFF
6	18.4	23.4	Lo			<ul style="list-style-type: none"> <li>• Sensible Heat Control (Lo)</li> <li>• On Timer preparatory operation + Auto Fan</li> <li>• Sleep mode (Cooling)</li> </ul>			
7	18.7	24.0				• Sensible Heat Control (Me <sup>-</sup> )		Auto Fan (Min.)	
8	19.3	24.4				• Manual Lo Fan + Powerful	Lo		• On Timer preparatory operation + Auto Fan
9	20.1	26.4				• Sensible Heat Control + Auto Fan			
10	21.4	27.1	Me <sup>-</sup>			• Sensible Heat Control (Me)			• Manual Lo Fan + Powerful
11	22.0	27.8		Auto Fan		• Sensible Heat Control + Auto Fan			• Auto Fan (min) + Powerful
12	22.7	28.3				• Manual Me <sup>-</sup> Fan + Powerful			
13	23.0	28.3		Auto Fan		<ul style="list-style-type: none"> <li>• Sensible Heat Control (Me<sup>+</sup>)</li> <li>• Auto Fan + Powerful</li> <li>• Sensible Heat Control + Auto Fan</li> </ul>	Me <sup>-</sup>		
14	23.1	28.4	Me			• Temporary Operation			
15	23.5	28.8		Auto Fan		• Auto Fan + Powerful		Auto Fan (Max.)	• Manual Me <sup>-</sup> Fan + Powerful
16	24.3	29.1				<ul style="list-style-type: none"> <li>• Manual Me Fan + Powerful</li> <li>• Sensible Heat Control (Hi)</li> </ul>			
17	25.0	29.8				• Auto Fan + Powerful	Me		• Temporary Operation
18	25.3	29.8	Me <sup>+</sup>						
19	26.0	30.1							• Manual Me Fan + Powerful
20	26.4	30.5				• Manual Me <sup>+</sup> Fan + Powerful			
21	26.4	30.7							
22	26.5	30.8	Hi			• Test Run			
23	27.3	31.1					Me <sup>+</sup>		
24	27.6	31.5				• Manual Hi Fan + Powerful			
25	28.0	31.9							• Manual Me <sup>+</sup> Fan + Powerful
26	28.3	32.3							
27	29.0	32.6				• SHi: Maximum Capacity Operation			• Auto Fan (max) + Powerful
28	29.3	32.6							
29	29.8	33.0							
30	29.8	33.4					SHi		<ul style="list-style-type: none"> <li>• Manual Hi Fan + Powerful</li> <li>• On Timer preparatory operation + Manual Fan + Powerful</li> <li>• Test Run</li> </ul>
31	32.7	36.9							• SSHi: Maximum Capacity Operation

(a) Cooling Automatic Fan Speed

The Automatic Fan Speed for cooling operation is shown as below:

(i) When Automatic Fan Speed is selected

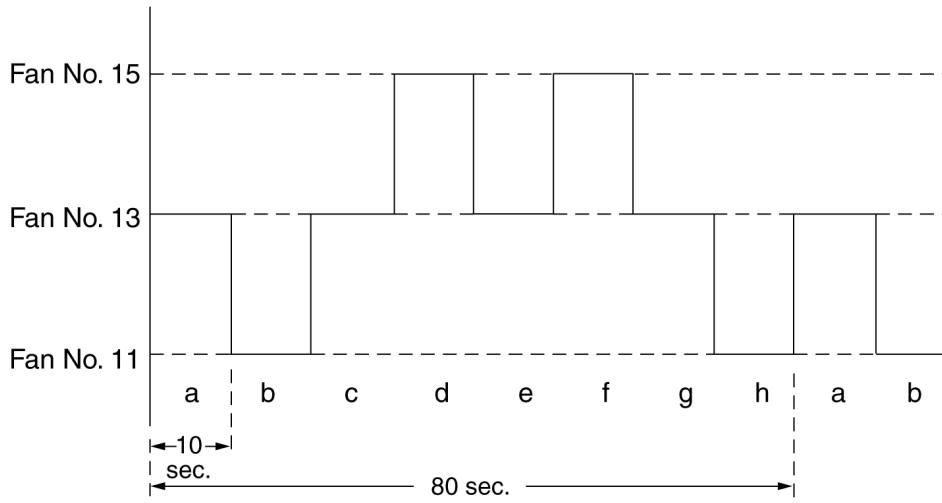

(ii) When Automatic Fan Speed and Powerful Mode are selected

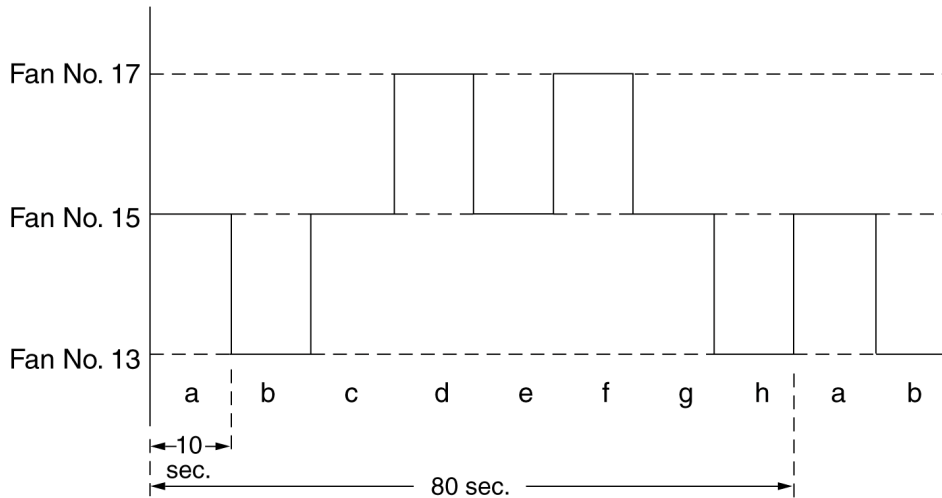

**Note:**

The Fan Speed will change every 10 seconds and it will be repeated from a to h every 80 seconds.

(b) Heating Automatic Fan Speed

The Automatic Fan Speed for heating operation is shown below:

- When the Automatic Fan Speed is selected, the Fan Speed will change every 10 seconds from Fan Speed No.7 to No.15 depending on indoor heat exchanger temperature. Each time the Fan Speed will move 1 rank up or down
- When Automatic Fan Speed and Powerful Mode are selected, the Fan Speed will change for every 10 seconds from Fan Speed No. 11 to No. 27 depend on heat exchanger temperature. Each time the Fan Speed will move 1 rank up or down.

## (c) Cooling Operation at SHi Speed

During Cooling operation, Indoor Fan speed is set at SHi when the following conditions occur:

- Outside air temperature is 30°C or above
- Compressor operates at 50Hz (CU-G95KE) or 70Hz (CU-G125KE) and above
- Remote control setting fan speed is High
- Indoor intake air temperature is 24°C or above
- Remote control setting temperature is 16°C
- Within 30 minutes after start of operation

## (d) Heating Operation at SSHi Speed

During Heating operation, Indoor Fan speed is set at SSHi when the following conditions occur:

- Heating operation for 2 hours or more
- When remote control setting fan speed is High
- Indoor intake air temperature is 17°C or above and less than 23°C
- Outdoor air temperature is below 4°C
- Remote control setting temperature is 30°C
- Compressor operates at 71Hz (CU-G95KE) or 90Hz (CU-G125KE) and above
- Airflow Direction is set at Manual

## 8. Outdoor Fan Control

- Outdoor fan motor is controlled with 1 speed only. Fan is in operation when the compressor starts operation and stops 30 seconds after compressor stops operation.

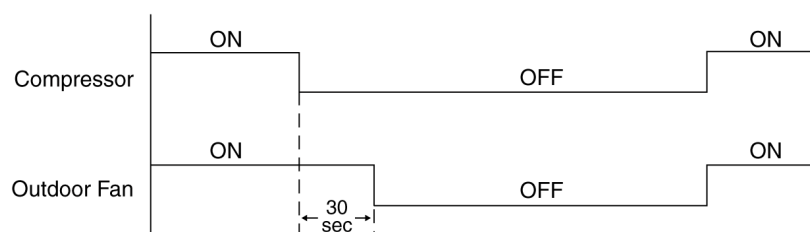

**9. Airflow Direction**

**A. Vertical Airflow Direction**

- Vane angle setting

Operation				Vane angle				
				1	2	3	4	5
Heating	Airflow direction auto	Indoor heat exchanger temperature	C	33°				
			B	70°				
			A	15°				
	Airflow direction manual	-	13°	33°	46°	57°	70°	
Cooling	Airflow direction auto	-	7° ~ 36°					
		Anti-dew formation control	11° ~ 25°					
	Airflow direction manual	-	7°	15°	25°	33°	41°	
		Anti-dew formation control	11°	15°	18°	22°	25°	
Soft Dry	Airflow direction auto	-	3° ~ 33°					
		Anti-dew formation control	11° ~ 25°					
	Airflow direction manual	-	3°	8°	18°	25°	33°	
		Anti-dew formation control	11°	15°	18°	22°	25°	
Fan	Airflow direction auto	-	7° ~ 36°					
	Airflow direction manual	-	7°	15°	25°	33°	41°	
Stop				143°				

- Setting angle

**Cooling, Soft Dry & Fan - Auto Airflow Direction**

Horizontal

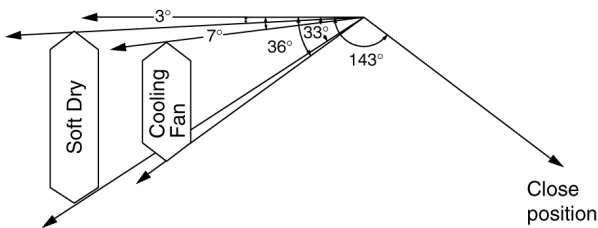

**Heating - Auto Airflow Direction**

Horizontal

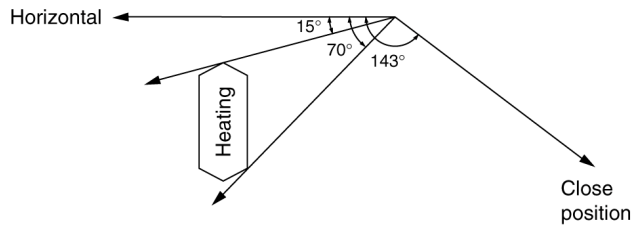

**Cooling, Soft Dry & Fan - Manual Airflow Direction**

Horizontal

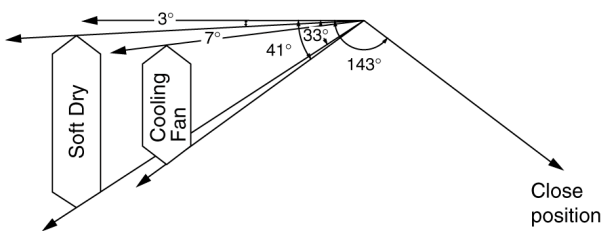

**Heating - Manual Airflow Direction**

Horizontal

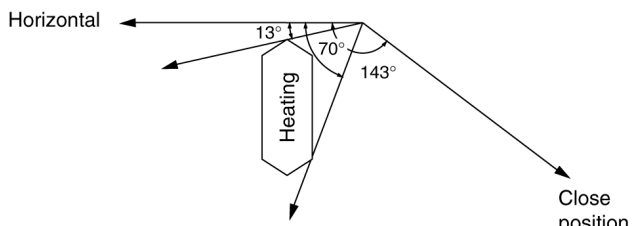

(a) Vertical Airflow Direction Manual

By pressing the remote control vertical airflow direction setting switch, the vane will move to the indicated angle (1, 2, 3, 4, 5) as shown in the table. When the remote control OFF/ON switch is pressed to stop the unit, the vane will move to the Close position.

(b) Vertical Airflow Direction Auto

By pressing the vertical airflow direction to AUTO, the vane swings up and down from 7° ~ 36° (during Cooling and Fan) and 3° ~ 33° (during Soft Dry). During Heating operation, the vane angle will shift according to the indoor heat exchanger temperature as shown below.

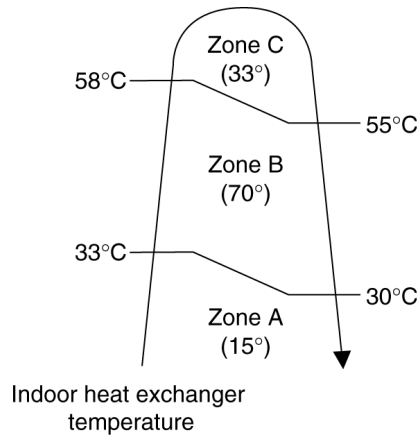

**B. Horizontal Airflow Direction**

(a) Automatic Horizontal Vane angle setting

By setting the horizontal airflow direction to AUTO, the vanes swing left and right from 55° ~ 125° during Cooling, Soft Dry and Fan operation. During Heating operation, the vane angle will shift according to the indoor heat exchanger temperature as shown below.

Operation		Left Vane Position	Right Vane Position
Heating	Indoor heat exchanger temperature	C	125°
		B	90°
		A	55°
Cooling		55° ~ 125°	55° ~ 125°
	Anti-dew formation control	64° ~ 110°	64° ~ 110°
Soft Dry		55° ~ 125°	55° ~ 125°
	Anti-dew formation control	64° ~ 110°	64° ~ 110°
Fan		55° ~ 125°	55° ~ 125°

**Heating**

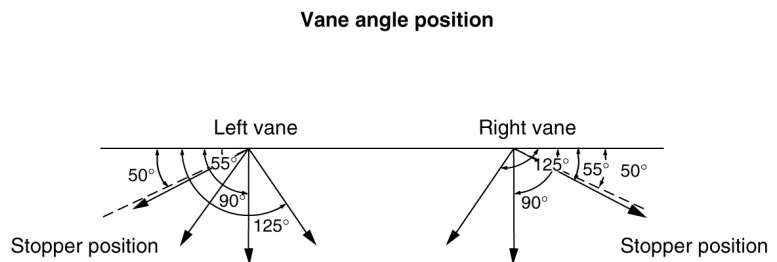
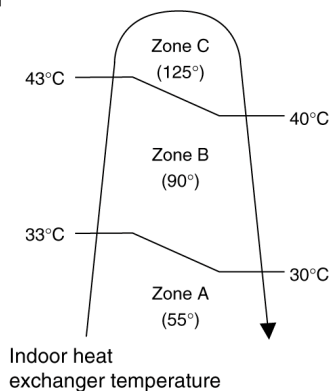

(b) Manual Horizontal vane angle setting

- By pressing the remote control horizontal airflow direction setting switch, the vane will move to the indicated position (1, 2, 3, 4, 5, 6, 7) as shown in the table.
- Horizontal van angle position

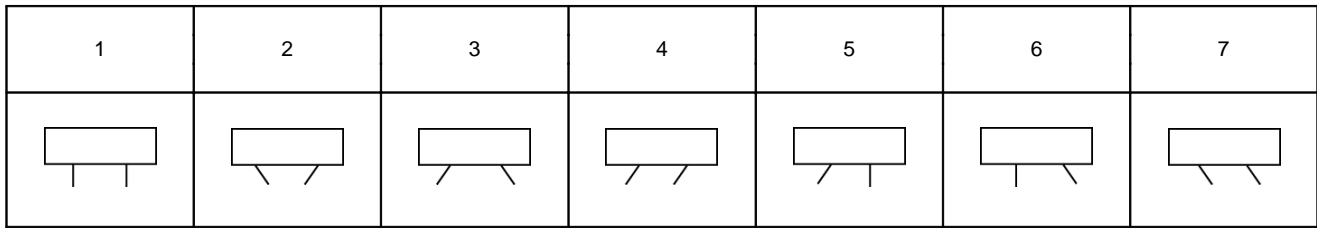

Operation		(Left vane position)							(Right vane position)						
		1	2	3	4	5	6	7	1	2	3	4	5	6	7
Heating		90°	125°	55°	55°	55°	90°	125°	90°	125°	55°	125°	90°	55°	55°
Cooling		90°	125°	55°	55°	55°	90°	125°	90°	125°	55°	125°	90°	55°	55°
	Anti-dew Formation Control	90°	110°	64°	64°	64°	90°	110°	90°	110°	64°	110°	90°	64°	64°
Soft Dry		90°	125°	55°	55°	55°	90°	125°	90°	125°	55°	125°	90°	55°	55°
	Anti-dew Formation Control	90°	110°	64°	64°	64°	90°	110°	90°	110°	64°	110°	90°	64°	64°
Fan		90°	125°	55°	55°	55°	90°	125°	90°	125°	55°	125°	90°	55°	55°

(c) Wide / Spot Airflow Setting

By pressing the remote control WIDE/SPOT switch, the vane will move to position 3 while WIDE and position 2 while SPOT.

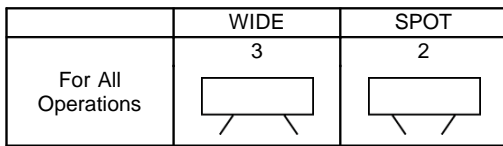

**10. Quiet Operation**

The purpose of this control is to reduce indoor operating noise. Indoor fan speed is set to Lo when the following conditions occur.

- Indoor fan speed is set at Low
- Indoor heat exchanger temperature rises to 17°C or above
- Compressor operates for 5 minutes or more
- Operation frequency is less than 33Hz (CU-G95KE) or 36Hz (CU-G125KE)

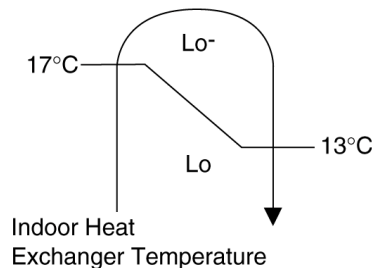

This control is cancelled when one of the following conditions occurs.

- Indoor fan speed is not set at Low
- Indoor heat exchanger temperature is decreased to 13°C or below
- Compressor operation frequency is more than 33Hz (CU-G95KE) or 36Hz (CU-G125KE)

**11. Powerful Mode Operation**

When the powerful mode is selected, the internal setting temperature will shift to achieve the setting temperature quickly.

(a) Cooling Operation

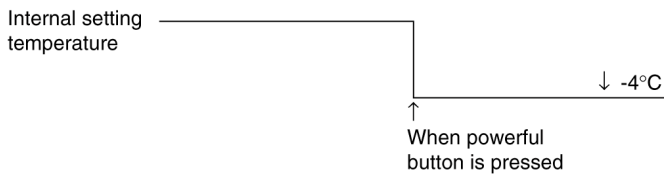

(b) Soft Dry Operation

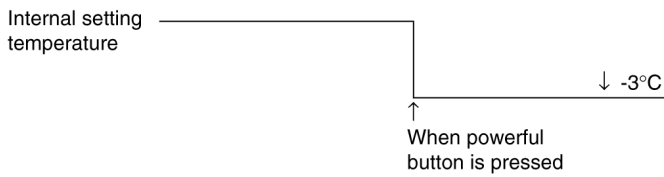

(c) Heating Operation

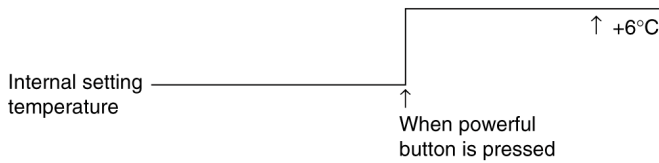

**12. Sleep Mode Operation**

(a) Cooling Operation / Soft Dry Operation

- When the sleep button is pressed, the remote control setting temperature will increase 0.5°C after 1 hour or when the remote control setting temperature is reached. After another hour, 0.5°C will be increased again.

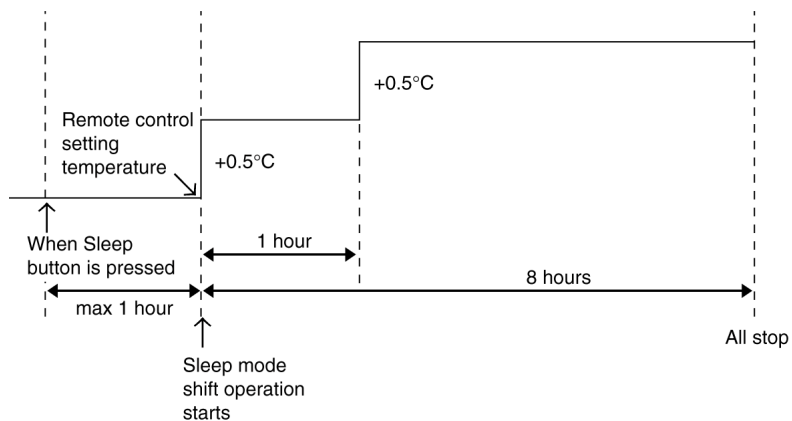

- ✘ • During sleep shift operation, indoor fan speed operates at Lo (for Cooling operation) or SLo (for Soft Dry operation).

(b) Heating Operation

- When the sleep button is pressed, the remote control setting temperature will decrease 2°C after 1 hour or when the remote control setting temperature is reached. After another hour, 3°C will be decreased again.

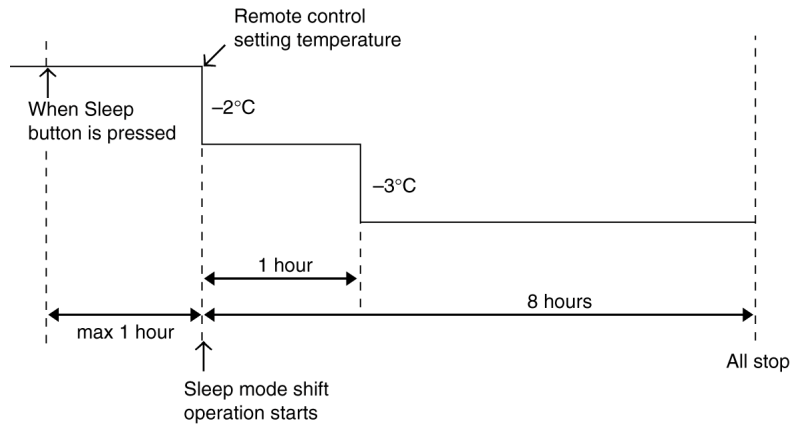

- ✕ • During sleep shift operation, indoor fan speed operates at Lo<sup>-</sup>.

**13. Delay On Timer Control**

- When the Delayed On Timer is set by using the remote control, the unit will start operate slightly earlier before the set time, so that the room will reach nearly the set temperature by the On Timer set time.
- 60 minutes before the set time, the indoor fan operates at Lo<sup>-</sup> and outdoor fan operates for 20 seconds to sense the indoor intake air temperature and outdoor air temperature in order to determine the starting time for preparatory operation. (The Power LED blinks during sampling.)
- The time of the preparatory operation will start before the On Timer set time.

(a) Cooling/Soft Dry

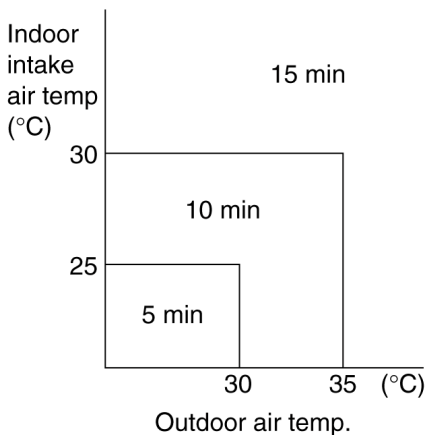

(b) Heating

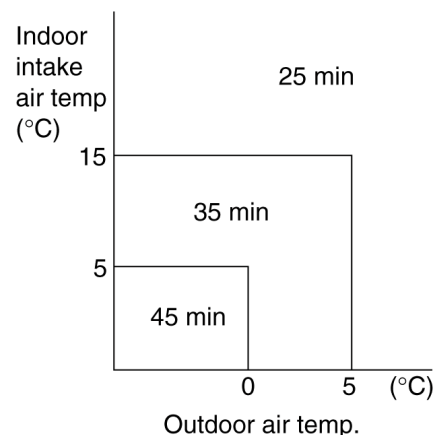

**14. Auto Restart Control**

- If there is a power failure, operation will automatically be restarted when the power is resumed from 2 minutes. 58 seconds to 3 minutes 52 seconds randomly. It will start with the previous operation mode and airflow direction.
- Auto Restart Control is not available when Timer or Sleep Mode is set.
- J1 at indoor electronic controller should be open circuit to cancel Auto Restart Control.



## 15. Power Monitor Display

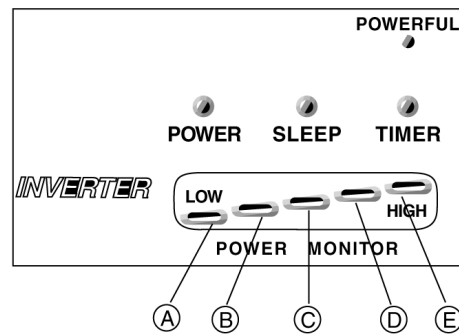

Power Monitor LED lights on when the compressor is in operation. The number of the LED lights on is in accordance to the compressor operating frequency.

Model	Display	A	A, B	A, B, C	A, B, C, D	A, B, C, D, E
CS-G95KE	Cooling & Soft Dry Indication Frequency (Hz)	15 ~ 26	31 ~ 33	36 ~ 40	43 ~ 46	51 ~ 64
	Heating Indication Frequency (Hz)	15 ~ 26	31 ~ 40	43 ~ 58	63 ~ 64	71 ~ 99
CS-G125KE	Cooling & Soft Dry Indication Frequency (Hz)	15 ~ 27	31 ~ 36	44 ~ 49	58 ~ 64	71 ~ 92
	Heating Indication Frequency (Hz)	15 ~ 27	31 ~ 44	58 ~ 79	83 ~ 86	91 ~ 115

## 16. Remote Control Signal Receiving Sound ON/OFF

- Press the Auto button (at indoor unit) for 16 seconds or < 21 seconds. “Beep” “beep” “beep” “beep” will be heard at 16th second. Remove the back cover of Remote Control, short the diagnosis (診断) terminals at the back of remote control to switch to Remote Control signal receiving sound ON/OFF mode. One “beep” will be heard\*. Then, press the Auto button once again, “beep” sound will be heard. The Remote Control signal receiving sound has been turned off.
- Repeat the above procedure or reset the main power supply to switch on the remote control signal receiving sound.

\* If “beep” “beep” sound is heard and “E1” or “E2” is displayed, the setting has been switched to H14 diagnosis mode. Refer Servicing Information for more details.

## 17. Indoor Power Relay Control

- The power relay turns on when one of the indoor LED lights on.
- The power relay turns off when all of the indoor LEDs lights off.
- When the air conditioner is stopped during operation, the power relay stays ON for 3 minutes.
- The power relay will turn off if a sudden power failure occurs  $\geq 0.05$  second. The power relay will turn on again after 3-4 minutes (Refer AUTO RESTART CONTROL). It will start with the previous operation condition before the power failure.

## 8.2. Protection

### 1. Protection Control For All Operations

#### a. Time Delay Safety Control

- The Compressor is not restarted for 3 minutes after stop of compressor.

#### b. 30 Second Forced Operation

- Once the compressor is ON, it will not turn OFF for 30 seconds. However, it is turned off by remote control or Automatic switch.

#### c. Total Running Current Control

- When the outdoor unit total running current (AC) exceeds I1, the frequency is lowered by 1 rank. If I1 is not exceeded for 30 seconds, the frequency is highered by 1 rank at one time. If the outdoor unit total running current exceeds I2, the compressor is immediately stopped for 3 minutes.

#### <Cooling, Soft Dry set value>

	Zone A		Zone B	
Model No.	CU-C95KE	CU-G125KE	CU-G95KE	CU-G125KE
I1 (A)	5.3	6.7	4.3	5.2
I2 (A)	7.3	10.8	7.3	10.8

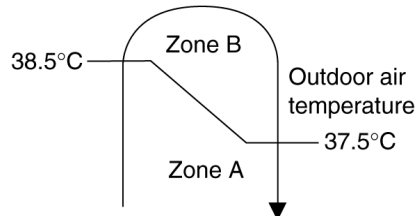

**Note:** Zone A will be used 30 minutes after operation starts.

#### <Heating set value>

Model No.	CU-G95KE	CU-G125KE
I1 (A)	6.1	9.2
I2 (A)	7.3	10.8

- If the outdoor unit total running current exceeds I2 3 times within 30 minutes, all indoor and outdoor relays will be turned off; TIMER LED will blink and F98 is displayed.

#### d. IPM (Power transistor) Prevention Control

##### 1. Overheating Prevention Control

- When the IPM (power transistor) temperature rises to  $100 \pm 10^{\circ}\text{C}$ , the compressor stops immediately. The compressor is restarted when the IPM (power transistor) temperature decreases to  $90 \pm 10^{\circ}\text{C}$  after 3 minutes (Time Delay Safety Control). If this condition occurs 4 times within 40 minutes, all indoor and outdoor relays will be turned off; TIMER LED will blink and F96 is displayed.

2. DC Peak Current Control

- When the electric circuit to the IPM (power transistor) exceeds the set value, DC 27 ± 4A, the compressor stops. The compressor restarts after 3 minutes.
- If within 30 seconds the set value is exceeded again, the compressor will stop for 1 minute. If this condition repeats for 7 times, all indoor and outdoor relays will be turned off; TIMER LED will blink and F99 is displayed.

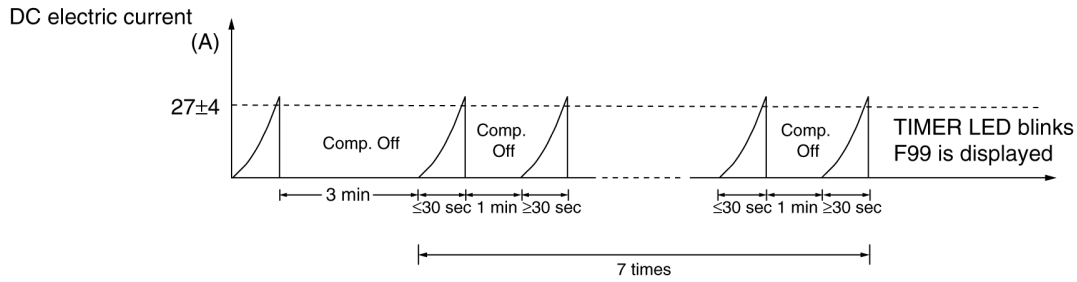

e. Compressor Overheating Prevention Control

- When the temperature of compressor rises to 105°C, the frequency is reduced as shown in diagram below. When the temperature rises to 115°C or above, the compressor stops. The compressor will start operating at low frequency when the temperature falls to 115°C and resume to normal condition when the temperature falls to 94°C.

Compressor temp. (°C)	115	Comp OFF	Comp OFF
	110	max 33 Hz (CU-G95KE) max 36 Hz (CU-G125KE)	max 33 Hz (CU-G95KE) max 36 Hz (CU-G125KE)
	106	max 40 Hz (CU-G95KE) max 49 Hz (CU-G125KE)	max 40 Hz (CU-G95KE) max 49 Hz (CU-G125KE)
	105		max 40 Hz (CU-G95KE) max 49 Hz (CU-G125KE)
	94	Free	Free
Condition			
	When temperature rises		When temperature falls

- The compressor stops when the temperature rises to 115°C. If this condition occurs 4 times within 20 minutes, all indoor and outdoor relays will be turned off; TIMER LED will blink and F97 is displayed.

f. Low Pressure Control (Gas Leakage Detection)

- When the following conditions as shown in the below table occur, the compressor stops and restarts after 3 minutes. If this phenomenon is continuously occurring twice within 30 minutes, all indoor and outdoor relays will be turned off; TIMER LED will blink and F91 is displayed.

Comp. Frequency ✕	51 Hz and above	71 Hz and above	70 Hz and above	90 Hz and above
Total Running Current ✕	≥ 1.88 A and < 1.9 A	≥ 1.88 A and < 2.1 A	≥ 1.88 A and < 2.4 A	≥ 1.88 A and < 2.7 A
Indoor Heat Exchanger Temp.	15°C or above	30°C or below	15°C or above	30°C or below
Operation	Cooling/Soft Dry	Heating	Cooling/Soft Dry	Heating
Model No.	CU-G95KE		CU-G125KE	

**Note:** The above conditions are not valid during Deice operation.

✕ This conditions are continuous for 5 minutes.

**g. Minimum Frequency Operation Protection**

- When the compressor operates at less than 31 Hz for 40 minutes, the operating frequency will increase to 31 Hz for 2 minutes.

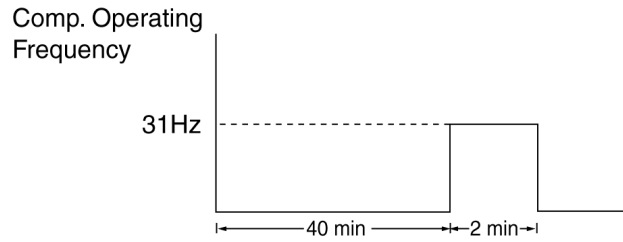

**h. Low Frequency Operation Protection**

Indoor intake air temp. (°C)	$\geq 30^{\circ}\text{C}$ or $< 15^{\circ}\text{C}$	$\geq 28^{\circ}\text{C}$ or $< 14^{\circ}\text{C}$
Outdoor air temp. (°C)	$\geq 38^{\circ}\text{C}$ or $< 16^{\circ}\text{C}$	$\geq 24^{\circ}\text{C}$ or $< 4^{\circ}\text{C}$
Indoor heat exchanger temp. (°C)	$< 30^{\circ}\text{C}$	$> 0^{\circ}\text{C}$
Operation	Cooling/Soft Dry	Heating

- When the above conditions occur, the compressor will operate at minimum frequency as below:-

	CU-G95KE	CU-G125KE
Cooling/Soft Dry	Min 31Hz	Min 31Hz
Heating	Min 33Hz	Min 36Hz

**i. Low Power Supply Voltage Protection**

- When the DC voltage supplied to IPM (Power transistor) is reduced to  $169 \pm 5\text{V}$  (CS-G95KE) or  $160 \pm 5\text{V}$  (CS-G125KE) the compressor stops and restarts after 3 minutes.
- If within 30 seconds after restarting of compressor, the DC voltage is reduced to  $169 \pm 5\text{V}$  (CS-G95KE) or  $160 \pm 5\text{V}$  (CS-G125KE) again, the compressor will stop for 1 minute.

If this condition repeats for 7 times, all indoor and outdoor relays will be turned off; TIMER LED will blink and F99 is displayed.

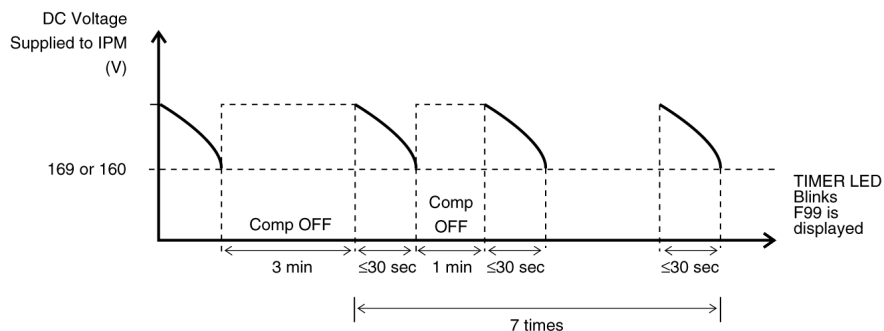

**j. High Power Supply Voltage Protection**

- When the voltage supply (AC) exceeds  $295 \pm 15\text{V}$  ( $T_0$ ), the air conditioner stops and restarts automatically when the voltage supply (AC) is below ( $T_0 - 5$ )V. However, waiting for 3 minutes is necessary for re-operation.

**2. Protection Control For Cooling & Soft Dry**

**a. Anti-Freezing Control**

- When the temperature of the indoor heat exchanger becomes low, the compressor operating frequency is reduced and stopped when the temperature falls to lower than 2°C continuously for 6 minutes. This is to prevent freezing of indoor heat exchanger. When the temperature rises to 10°C or above, the compressor restarts with 3 minutes. The compressor operating frequency will resume to normal when the temperature reaches 14°C.
- Indoor fan speed will increase when the temperature falls and it will resume to original speed when the temperature increases to 14°C for 5 minutes continuously.

Indoor Heat Exchanger temp. (°C)	14	Free	Original	Free	Original
	12			Max 36 Hz (CS-G95KE) Max 44 Hz (CS-G125KE) Max 26 Hz (CS-G95KE) Max 27 Hz (CS-G125KE)	
	10	Shift ※	Shift ※	OFF	Shift ※
	6				
	4	Max 36 Hz (CS-G95KE) Max 44 Hz (CS-G125KE) Max 26 Hz (CS-G95KE) Max 27 Hz (CS-G125KE)		OFF	
	2	OFF			
		Comp.	Indoor Fan	Comp.	Indoor Fan
		When the temp. falls		When the temp. rises	

Fan Speed	Shift ※
Me+	2 rank up
Me	1 rank up
Me-	1 rank up
Lo	2 rank up
AUTO FAN	1 rank up

**Note:** The above phenomenon occurs when the fan is running at Me+ or below.

**b. Anti-Dew Formation Control**

- When the following conditions occurs for 20 minutes continuously, anti-dew formation is controlled:
  1. Indoor intake air temperature is 24°C or above.
  2. Outdoor air temperature is less than 30°C.
  3. Remote control setting temperature is less than 25°C.
- During anti-dew formation control, compressor operates at 36 Hz (CS-G95KE) or 44 Hz (CS-G125KE) and airflow direction vane move slightly (as shown in Airflow Direction Control). Indoor fan speed will shift as below:

Fan Speed	Shift
Hi	2 rank down
Me+	3 rank up
Me	unchange
Me-	unchange
Lo	2 rank up

- This control is cancelled immediately when either condition 1-3 as written above is changed, or remote control setting temperature or fan speed is changed.

### C. Anti-Fog Discharge Control

- The compressor operating frequency is regulated by operation time to prevent fog discharged from indoor until as shown in the table below.

		Compressor operating frequency	
Operation Time, T (min)	$0 \leq T < 30$	50Hz	70Hz
	$30 \leq T < 90$	46Hz	64Hz
	$T \geq 90$	43Hz	58Hz
Model No.		CU-G95KE	CU-G125KE

- Note:**
- Indoor fan is running at Me<sup>-</sup> or below.
  - After 420 minutes from the start of operation, the operation timer counting is restarted from "0".

### d. High Pressure Control at Minimum Frequency Control

- When the outdoor air temperature increases to 38.6°C, compressor operating frequency reduces to minimum of 31 Hz. Compressor operating frequency will resume to normal when outdoor air temperature decreases to 37.8°C.

**3. Protection Control For Heating Operation**

**a. Intake Air Temperature Control**

- When the intake air temperature is 10°C or above and remote control setting fan speed is less than Me, the compressor operates maximum at 71 Hz (CU-G95KE) or 90 Hz (CU-G125KE).
- When the intake air temperature is 30°C and above, the compressor operates maximum at 71 Hz (CU-G95KE) or 90 Hz (CU-G125KE).

**b. Outdoor Air Temperature Control**

- The compressor operating frequency is regulated in accordance to the outdoor air temperature as shown in the diagram below. This control will begin 50 seconds after the compressor starts.

Outdoor air Temperature (°C)	21	43 Hz	43 Hz	58 Hz	58 Hz
	19	64 Hz	64 Hz	86 Hz	86 Hz
	12	Free	Free	Free	Free
	10				
Condition		When temp. rises	When temp. falls	When temp. rises	When temp. falls
Model No.		CU-G95KE		CU-G125KE	

**C. High Pressure Control**

- The compressor operating frequency is regulated in accordance to the indoor heat exchanger temperature.

Indoor heat exchanger temp. (°C)	59	OFF	OFF	OFF	OFF
	53	33 Hz	33 Hz	36 Hz	36 Hz
	51		Max 43 Hz		Max 58 Hz
	47	Min 33 Hz	Max 53 Hz	Min 36 Hz	Max 74 Hz
	43		Min 33 Hz		Min 36 Hz
	37	Free	Free	Free	Free
Condition		When temp. rises	When temp. falls	When temp. rises	When temp. falls
Model No.		CU-G95KE		CU-G125KE	

## 9 Operating Instructions

### SAFETY PRECAUTIONS

Before operating, please read the following “Safety Precautions” carefully.

To prevent personal injury, injury to others and property damage, the following instructions must be followed.

- Incorrect operation due to ignoring of instructions will cause harm or damage, the seriousness of which is classified as follows:



**Warning** : This sign warns of death or serious injury.



**Caution** : This sign warns of injury or damage to property.

- The instructions to be followed are classified by the following symbols:



This symbol (with a white background) denotes an action that is PROHIBITED.



These symbols (with a black background) denotes an action that is COMPULSORY.

### Installation precautions



#### Warning

- **Do not install, remove and reinstall the unit yourself.**

Improper installation will cause leakage, electric shock or fire. Please consult an authorized dealer or specialist for the installation work.



#### Caution

- **This room air conditioner must be earthed.**



Improper grounding could cause electric shock.

- **Ensure that drainage piping is connected properly.**



Otherwise, water will leak out.

- **Do not install the unit in a place where there may be explosive gas leaks.**



Gas leaks near the unit could cause fires.



## Operation precautions



### Warning

■ **Insert the power plug properly.**

Heat generated by a loose power plug could cause electric shock or fire. Electrical outlet and power plug shall be easily accessible.

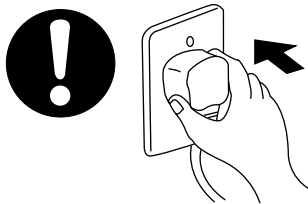

■ **Do not operate or stop the unit by inserting or pulling out the power plug.**

It could cause electric shock or fire.

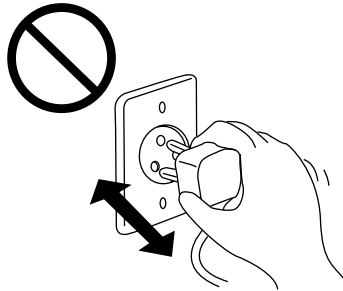

■ **Do not damage the power cord or use an unspecified power cord.**

A damaged/unspecified power cord could cause electric shock or fire.

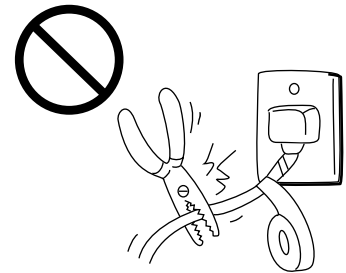

■ **Do not modify the length of the power cord or use an extension cord.**

It could cause electric shock or fire.

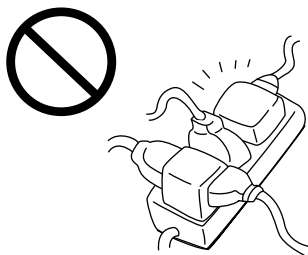

■ **Do not operate the unit with wet hands.**

It could cause an electric shock.



■ **Do not insert finger, sticks or other objects into the units.**

It could lead to physical injury and cause damage to the units.

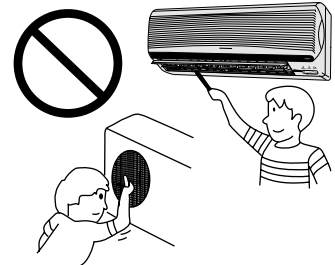

■ **Do not be directly exposed to the cold airstream for too long.**

It could lead to health problems.

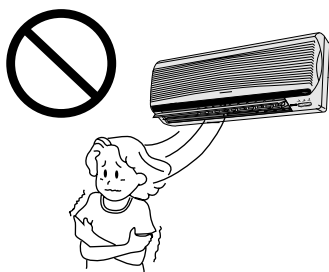

■ **If there is a smell of burning, stop the air conditioner and disconnect the power supply.**

Please consult an authorized dealer or service center.

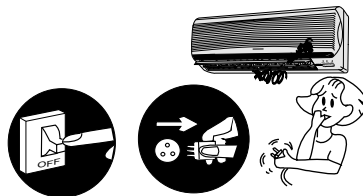

Switch off the breaker. Disconnect the power plug.

■ **Do not try to repair the unit yourself.**

It could lead to fire or cause an electric shock. Please call an authorized dealer or service center.

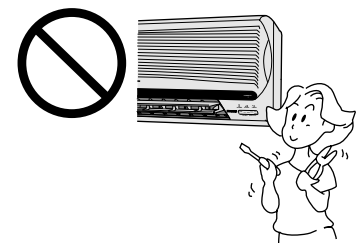



## Caution

- **Do not remove the power plug by pulling the cord.**  
Hold the plug when disconnecting the plug from the wall outlet.

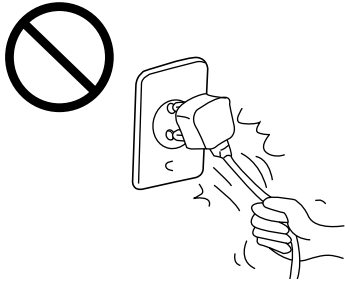

- **Switch off the power supply if the unit is not going to be used for a long period of time.**  
If dust accumulates on the plug, it will generate heat and this could cause a fire.

Switch off the breaker.



Disconnect the power plug.

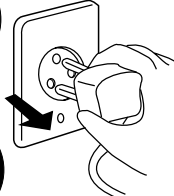

- **When cleaning the unit, remove the plug.**  
This is to prevent injury due to the rotating fan in the unit.

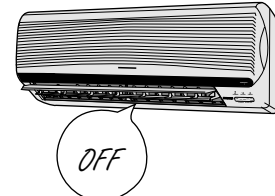

- **Do not use for other purposes.**  
Do not use for preservation purposes. It will affect food quality, animals or plants.

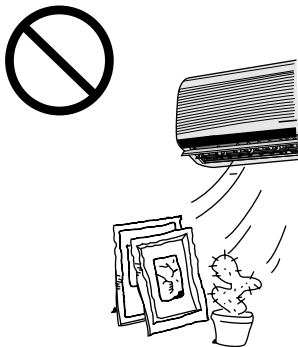

- **Do not place combustor in the path of the airflow from the unit.**  
Incomplete combustion could cause toxic gas (CO) poisoning.

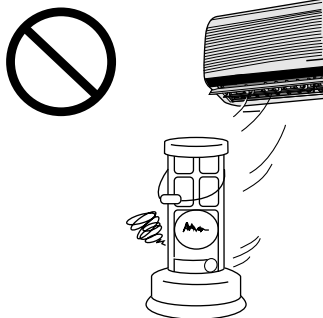

- **Ventilate the room regularly.**  
Since windows are kept closed, it does good to open them periodically to ventilate the room.

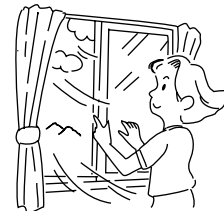

- **Do not wash the unit with water.**  
It could cause an electric shock.



- **Inspect the unit for any damage.**  
Ensure that the necessary repairs are carried out.

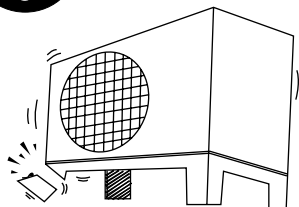

- **Do not sit or place anything on the outdoor unit.**  
You might fall off or the unit might collapse.

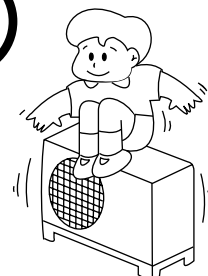

# Name of Each Part for Inverter Aided Air Contioner

## Indoor unit

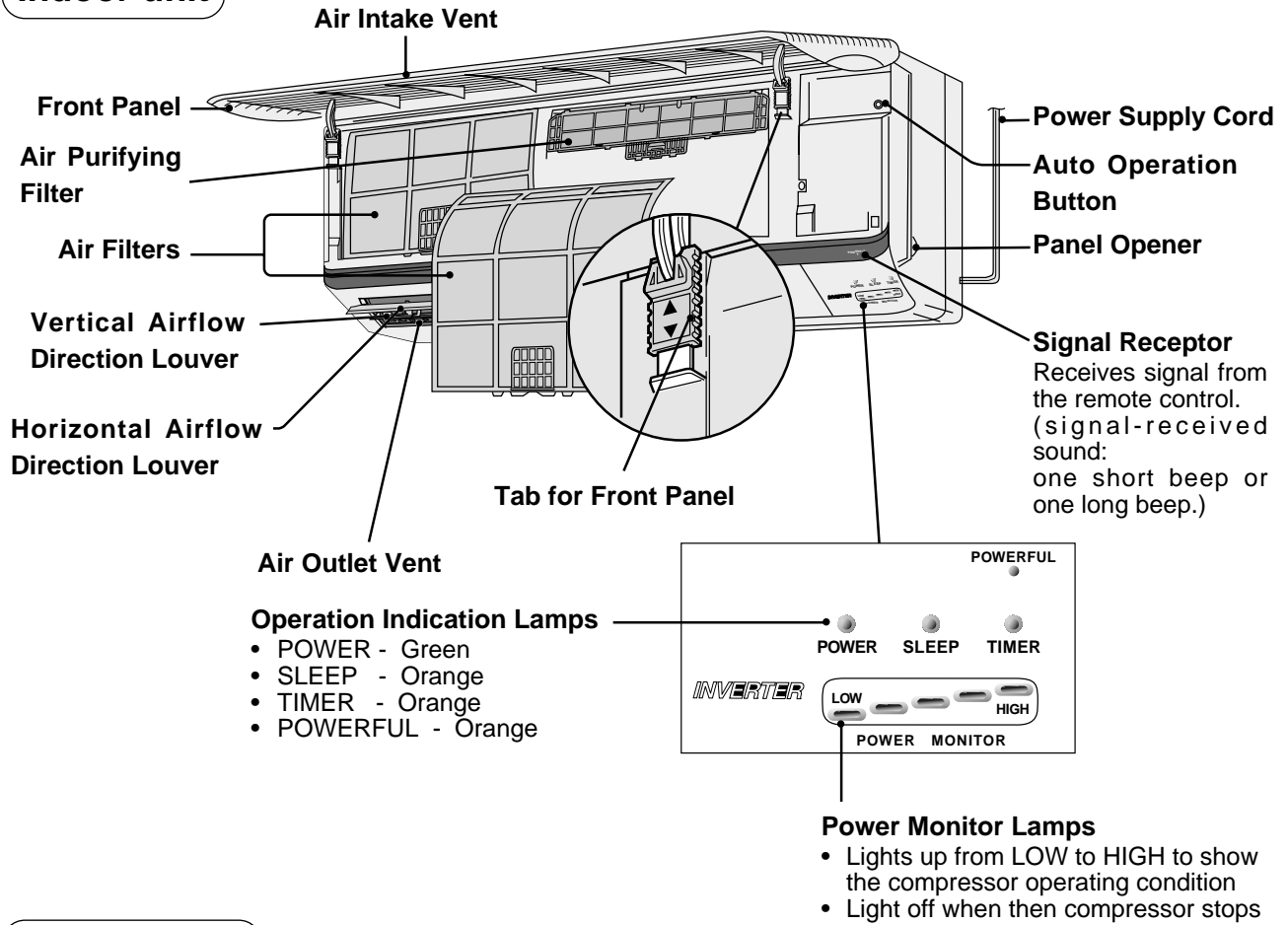

## Outdoor unit

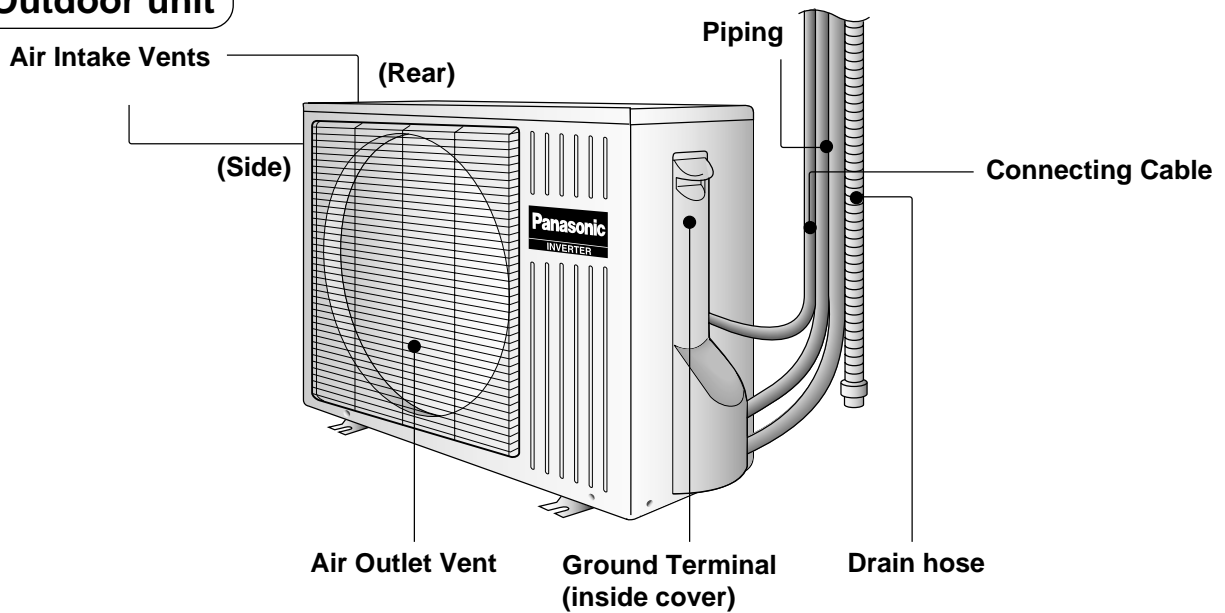

## Remote control

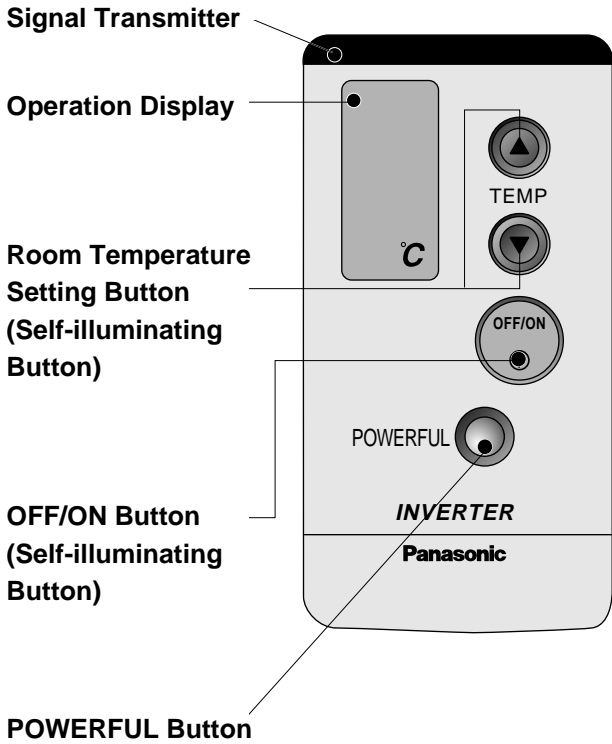

## When back cover is open

### Diagnostic Terminals

To be used by the service **Reset points** technician only.

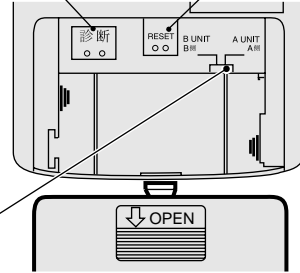

### Signal [B ↔ A] Switch

To be set to A.  
When two units are installed in the same room. Consult your dealer.

## Open the remote control door

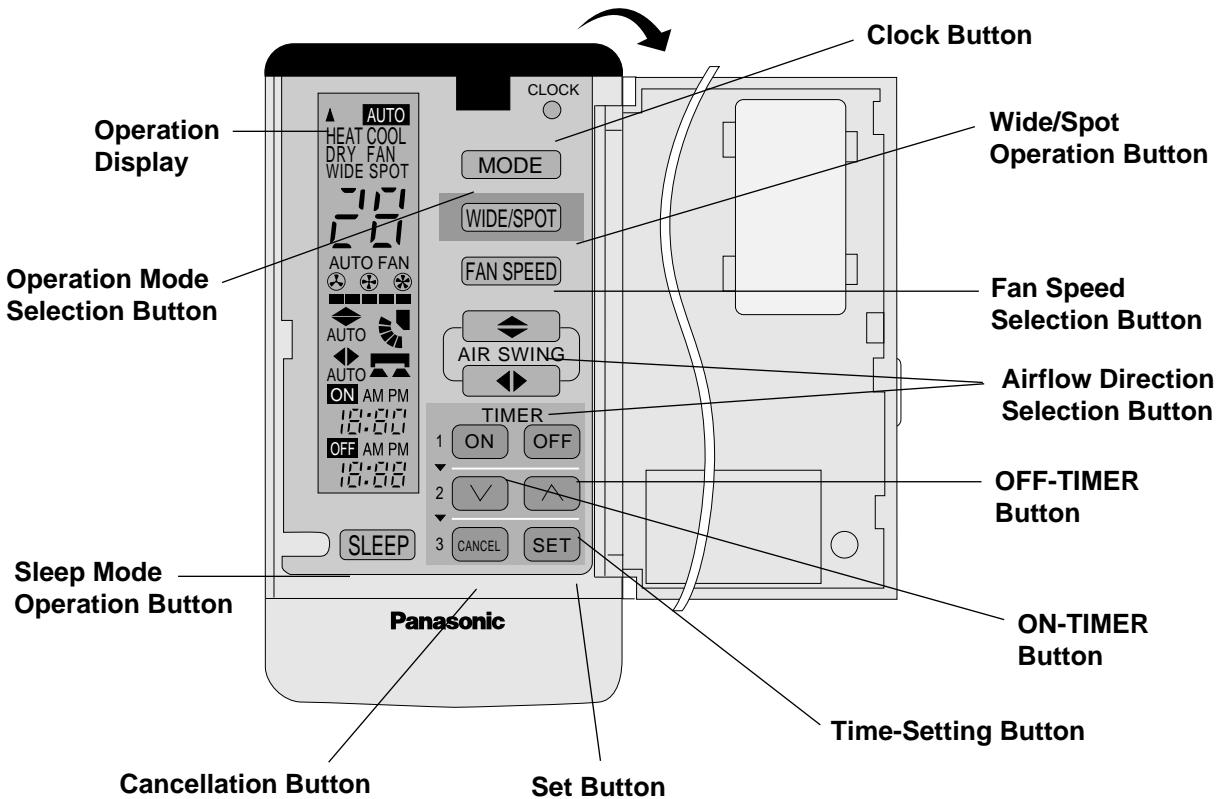

## Preparation (Indoor Unit • Remote Control)

### Indoor Unit

- 1 Insert the power supply plug into an electrical outlet and open the front panel.

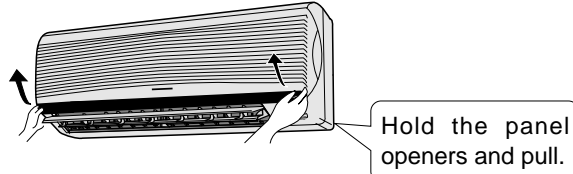

- 2 Remove the air filters and insert the air purifying filters.

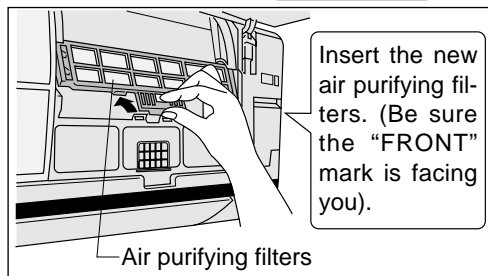
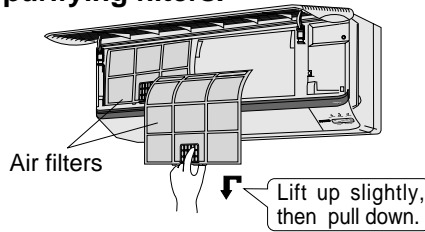

- 3 Insert the air filters and close the front panel.

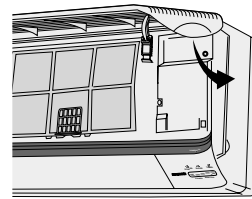

### Warning

- Ensure that the power supply plug is securely inserted.

A loose plug may cause a fire or an electric shock.

Use under the following conditions:

Unit in °C

		DBT: Dry Bulb Temperature WBT: Wet Bulb Temperature	Max. Temperature	Min. Temperature
COOLING	Indoor	DBT	32	16
		WBT	23	11
	Outdoor	DBT	43	16
		WBT	26	11
HEATING	Indoor	DBT	30	2
		WBT	-	-
	Outdoor	DBT	24	-5
		WBT	18	-6

### Notes

- If the unit is not going to be used for an extended period of time, turn off the Power Supply. If it is left at the ON position, approximately 2.8 W of electricity will be used even if the indoor unit has been turned off with the remote control. When standby mode is activated, approximately 35 W of electric power will be consumed on the heat of compressor to warm up the room quickly. This mode can be switched off if you do not require it. Please consult your dealer.
- If operation is stopped, then restarted immediately, the unit will resume operation only after 3 minutes.

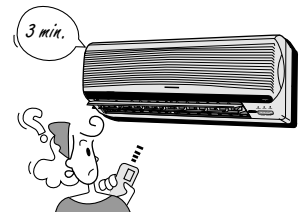

## Remote control

### Operating the remote control

- The maximum distance at which signals can be received is about 10 m.
- Aim the remote control at the signal receptor on the room air conditioner when operating.
- Make sure that the signal path is not obstructed.

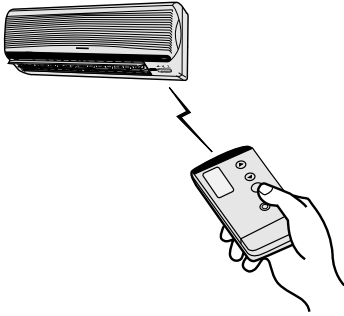

### Inserting batteries

(2 pcs R03 dry-cell batteries)

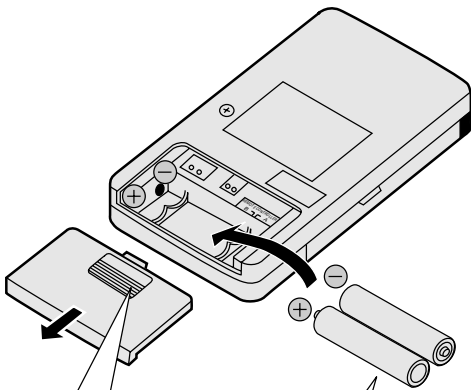

1 Gently press the place marked **OPEN** and slide the cover towards you.

2 Be sure that the **+** and **-** directions are correct.

- Confirm that the display is flashing 12:00 PM. If the display does not appear when the batteries are inserted, remove them and re-insert.



- To prevent battery exhaustion, set the current time (CLOCK) immediately.

## Batteries

The batteries can be used for approximately one year.

### Observe the following when replacing the batteries

- Replace the batteries with 2 new batteries of the same type.
- Do not use rechargeable batteries (Ni-Cd), because they are different from standard dry-cell batteries in shape, dimensions and performance.
- If the unit is not going to be used for an extended period of time, remove the batteries from the remote control.

### Setting the clock

1

Press the **Clock** button.



PM flashes and 12:00 lights up.

2

Press **▼** or **▲** to set the current time.



Press **▲** continuously for fast forwarding and **▼** for fast reversing.

3

Press the **Clock** button.

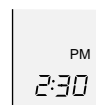

AM or PM lights up.

## Notes

- Do not throw or drop the remote control. Do not let it get wet.
- Certain types of fluorescent lamps may affect signal reception. Consult your dealer.

# Automatic • Heating • Cooling • Soft Dry • Fan

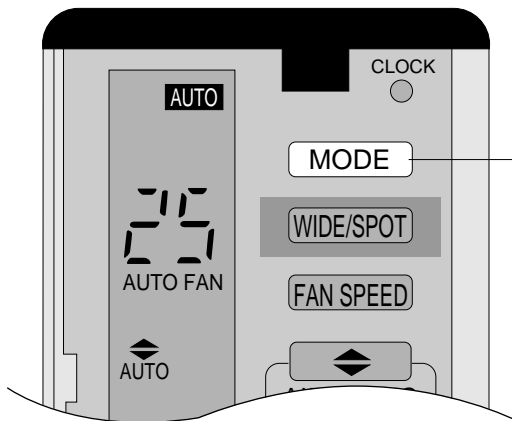

**1** Press **MODE** to select the desired operation

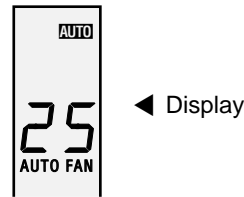

When pressed, the display changes in this order.

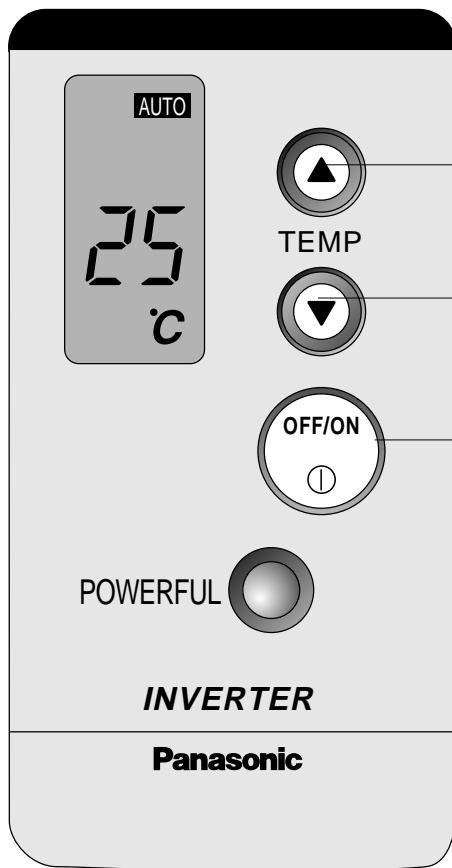

**2** Press **OFF/ON** Button

The Power LED lights up. (LED blinks when the room temperature is low at the start of heating or operation mode is selected during Automatic Operation.)

The power monitor lamps light up to show the compressor operating condition.

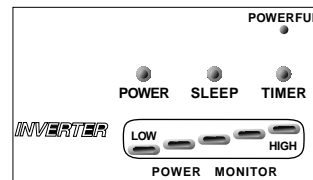

**3** To set the temperature

- Increases or decreases by 1°C when pressed.
- The temperature can be set between 16°C and 30°C. (Not adjustable during Fan Operation.)

Recommended temperature:	
Heating	: 20 ~ 24°C
Cooling	: 26 ~ 28°C
Soft Dry	: Approx. room temperature

Press **OFF/ON** Button again to stop operation (POWER LED lights off).

## Auto Restart Control

- If there is a power failure, operation will be automatically restarted under the previous operation mode and airflow direction when power is resumed. (When the operation is not stopped by remote control).
- If you do not want the unit to restart automatically when power is resumed, switch off the power supply.
- If you do not require Auto Restart Control, consult your dealer.
- Auto Restart Control is not available when Timer or Sleep Mode is set.

## Automatic Operation

- At the start of the Automatic operation, Heating, Cooling or Soft Dry is automatically selected according to the outdoor temperature, indoor temperature and setting temperature.
- The operation mode changes every half hour, when necessary.

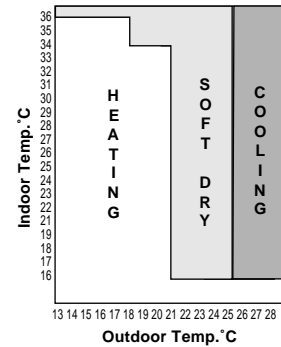

## Heating Operation

- To warm up the room temperature upon your preference setting temperature.
- Heat is obtained from outdoor air to warm up the room. When the outdoor ambient air temperature falls, the heating capacity of the unit might be reduced. We recommend that you use an additional heating device when the outdoor ambient air temperature is low.

## Cooling Operation

- To cool the room temperature upon your preference setting temperature.

## Fan Operation

- Circulates air throughout the room.
- Purifies and deodorizes the air if the air purifying filter is used. Fan Operation is recommended during seasons in which neither Heating nor Cooling is used.

## Soft Dry Operation

- Dehumidifies while maintaining the setting temperature. The Soft Dry Operation is recommended during the rainy season.
- If the room temperature exceeds the setting temperature, operation switches to Cooling.
- The fan speed is rather slow during Soft Dry Operation.
- The humidity may not decrease when the indoor temperature is lower than the setting temperature on the remote control.

## Notes

- See page 12 on how to adjust the fan speed and airflow direction.
- The Powerful and Sleep modes can be set during Automatic Operation.



## Adjusting Airflow Direction and Fan Speed

Proper adjustment of airflow direction and fan speed increases operation effectiveness.

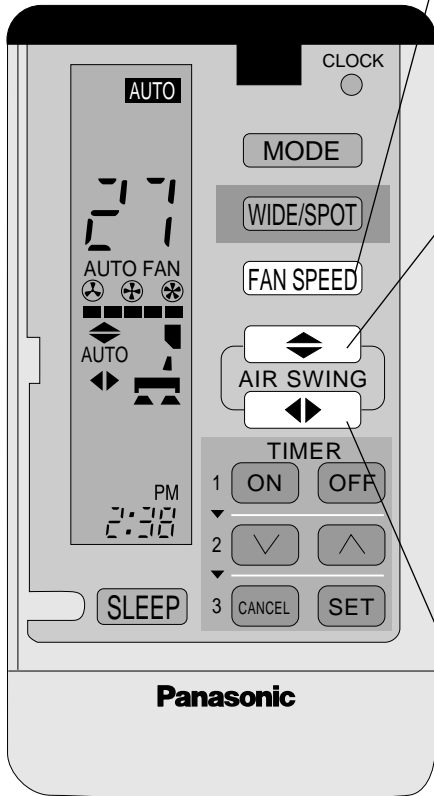

### To adjust fan speed

Press **FAN SPEED Button**

- There are five stages of fan speed in addition to Auto Fan Speed.

#### ■ Auto Fan Speed Control

##### Heating

When the temperature of the discharge air increases, the fan speed increases.

##### Cooling ● Soft Dry

Changes the fan speed to generate a cool breeze. The air starts to blow out approximately 40 seconds after the start of Cooling or Soft Dry.

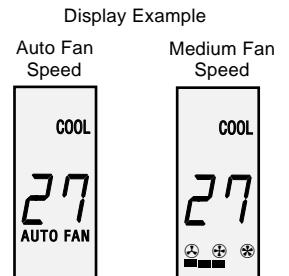

### To adjust the vertical airflow direction louvers

Press **↕ Button**

- There are five angles of vertical direction in addition to Auto Airflow Direction.



The display changes when the **↕** button is pressed. (The display indicates airflow direction.)

#### ■ Auto Vertical Airflow Direction Control

##### Heating

When the discharge air temperature is low such as at starts of heating operation, the air blows at horizontal level.

As the temperature rises, the hot air blows in a downwards direction.

##### Cooling ● Soft Dry

The louver swings up and down automatically.

### To adjust the horizontal airflow direction louvers

Press **↔ Button**

- There are seven positions of the horizontal airflow direction louvers in additional to Auto Airflow Direction.

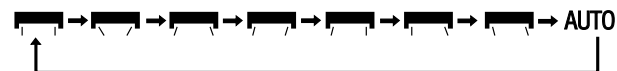

The display changes when the **↔** button is pressed. (The display does not show the exact directions of airflow or the exact louver angles.)

#### ■ Auto Horizontal Airflow Direction Control

##### Heating

When air temperature is low, air is sent in WIDE. When temperature goes up, air comes out in SPOT.

##### Cooling ● Fan

Louvers swing horizontally at a fixed speed.

##### Soft Dry

Louvers are fixed to WIDE.

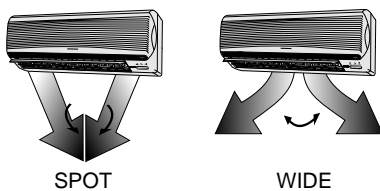

## Louver adjustment range

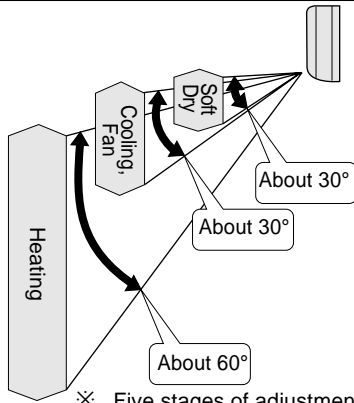

※ Five stages of adjustments can be made in this range.

- The adjustment range is different for each operation i.e. Heating, Cooling and Soft Dry. (Fig. at left)
- The angle indicated on the remote control is different from that on the indoor unit.
- The louver angle automatically changes to prevent condensation during Cooling and Soft Dry.
- When operation stops, the louver automatically closes.

## Notes

- Do not adjust the vertical airflow direction louver downward during Cooling and Soft Dry. Drops of water may condense on the air outlet vent and drip down.
- Use the remote control to change the vertical airflow direction louver. Using your hands to adjust the direction may cause the louver to malfunction. If this happens, stop operation immediately and restart.

## WIDE / SPOT

Convenient control of horizontal airflow direction.

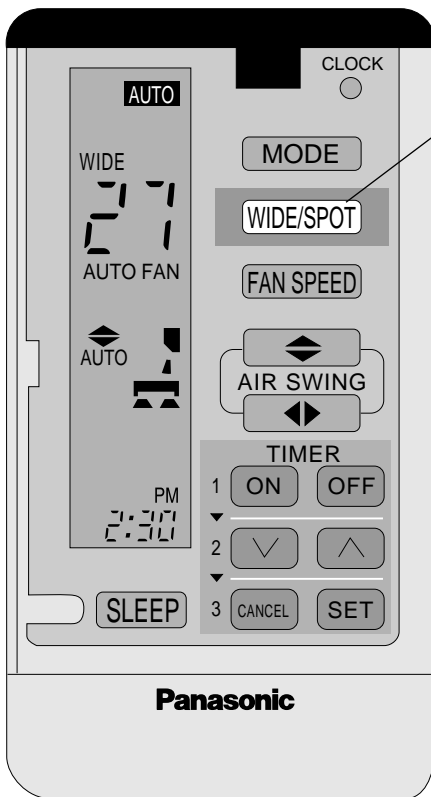

- Press **WIDE/SPOT** button to select WIDE or SPOT airflow direction.

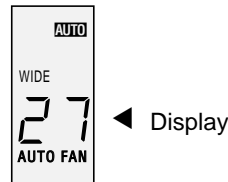

◀ Display

When pressed, the display changes in this order.

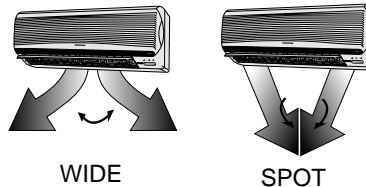

- To cancel WIDE or SPOT, press **◀▶**.

## Setting the Timers

Set the **ON** to the time at which you want heating or cooling to begin. Set the **OFF** to the desired stop time. Use both timers together for maximum comfort and efficiency.

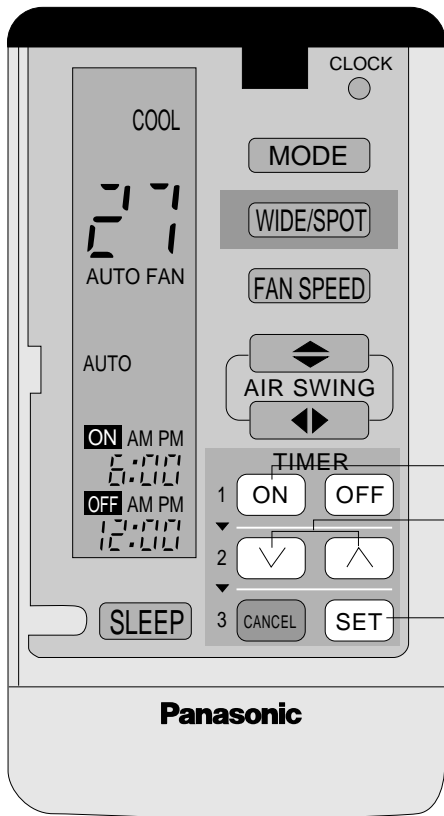

**1 Press ON Button**  
Display Ex: Set the ON timer for 7:00AM.

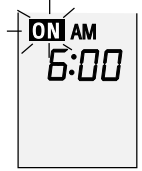

**2 Press V or ^ to set the time**  
● Increases or decreases by 10 minutes. Press continuously to reach the desired setting time quickly.



**3 Press SET Button**



### ■ To set OFF-Timer

Press **OFF** and follow steps 2 and 3.

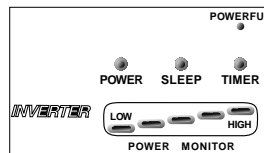

(TIMER LED on the indoor unit lights up.)

### ■ To cancel the timer

(Ex) Cancel ON timer.

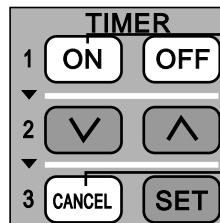

**1 Press ON Button**

**2 Press CANCEL Button**

(TIMER LED on the indoor unit lights off.)

● **When you sleep**



Set the time at which you will go to sleep with the **OFF**.  
This prevent wasting of electricity.

● **When you wake up**

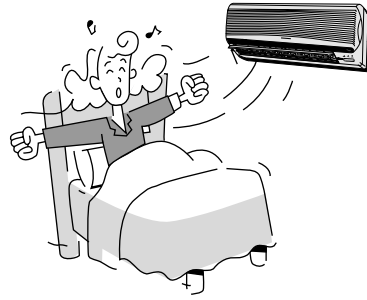

Set the time at which you will wake up with the **ON**.  
You can start the new day at a comfortable temperature.

● **When going out**



Set the time at which you will go out with the **OFF**.  
Set the time at which you will come back with the **ON**.  
This will prevent the air conditioner from being left on while you are out, and the temperature will be pleasant when you return.

● **When you return**

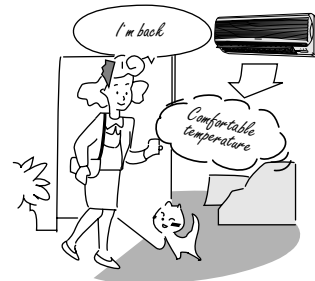

Set the time at which you will return with the **ON**.  
Set the time at which you will go to sleep with the **OFF**.  
This will make the temperature pleasant when you return, and it will prevent the air conditioner from being left on.

## Timer

- When the ON-Timer is set, operation will start before the actual set time. This is to allow the room temperature to reach the setting temperature by the setting time (maximum of 45 minutes in advance).
- Once the ON-Timer is set, operation will start at the setting time everyday.
- The current time is not displayed when the timers are set.
- When both timers are used together the TIMER LED on the indoor unit remains lit even if the operation is stopped by the OFF-Timer.

## Powerful • Sleep

Powerful and Sleep modes are available for Automatic Operation, Heating, Cooling and Soft Dry.

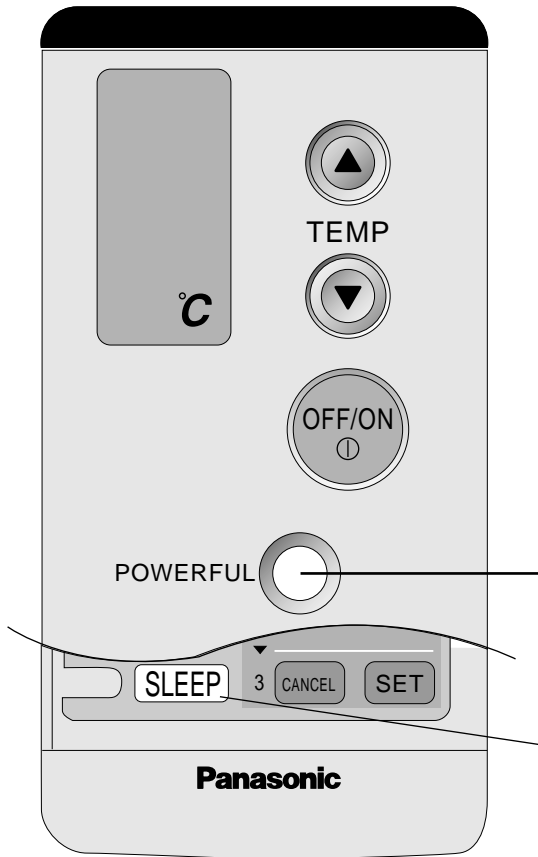

### Powerful mode operation

- Used in winter to warm yourself quickly upon returning home (Heating + Powerful).
- Used in summer to cool yourself after a hot bath (Cooling + Powerful).

Press **POWERFUL** during operation

#### ■ To cancel

Press **POWERFUL** again.  
(The Powerful display on the remote control disappears.)

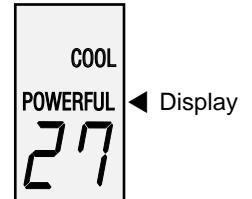

#### Note

- The setting temperature and the fan speed changes automatically in order to heat, cool or dehumidify the room quickly.

Operation		Temperature	Fan Speed
Automatic	Heating	6°C higher	Slightly stronger
	Cooling	4°C lower	
	Soft Dry	3°C lower	

### Sleep mode operation

Prevents overheating and overcooling during sleep. Stops automatically after 8 hours.

Press **SLEEP** during operation

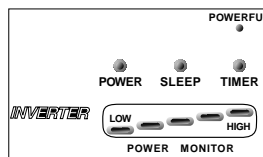

(SLEEP LED on indoor unit lights up.)  
Not displayed on remote control.

#### ■ To cancel

Press **SLEEP** again. (SLEEP LED on indoor unit lights off.)

#### Notes

- Air blows out gently during sleep.
- When used in conjunction with the Timer, the Timer has priority.

#### COOLING & SOFT DRY OPERATION

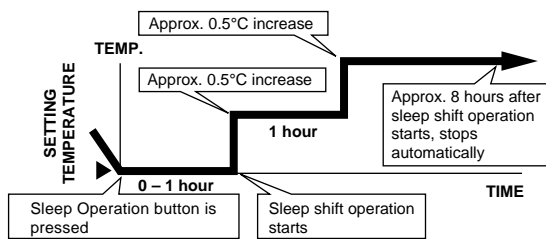

#### HEATING OPERATION

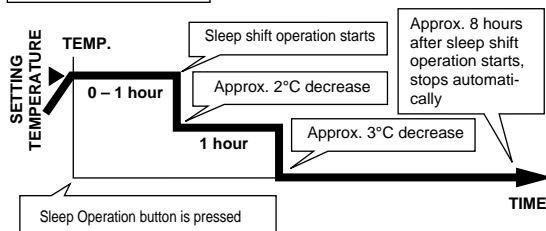

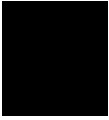

### Adjust your curtains and blinds

Adjust curtains and blinds to prevent sunlight from entering the room directly as this may reduce the cooling efficiency.

### Do not overcool!

A difference of 6°C or less between the outdoor and indoor temperatures during cooling is ideal. Anything cooler may harm your health.

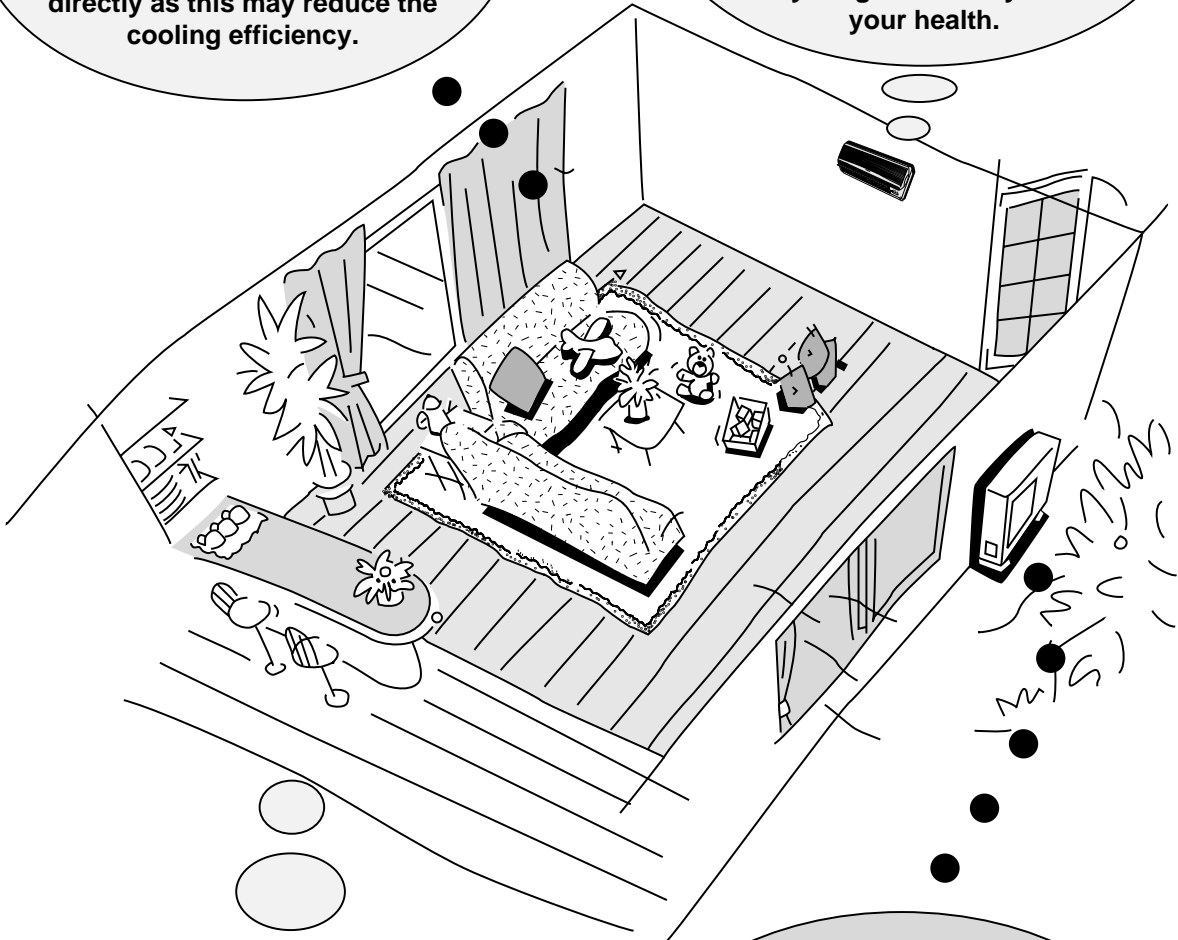

### Clean the filters!

A dirty air filter reduces heating and cooling efficiency. Clean the filters every 2 weeks.

### Anything near the outdoor unit?

Objects placed near the outdoor unit will reduce heating and cooling efficiency.

## Care and Maintenance

Regular cleaning and servicing will prolong the life of your air conditioner.



### Caution

■ **Before cleaning the air conditioner, set the Power supply to OFF.**

The high fan speed may cause injury.

■ **Do not wash the unit with water.**

Water may cause a short circuit or electric shock.

### Cleaning the indoor unit and remote control

- Wipe gently with a soft, dry cloth.
- Do not clean with water hotter than 40°C, volatile liquids such as paint thinner, or polishing fluids. (When using chemically treated cloth, refer to the instructions and precautions.)
- The front panel can be removed and cleaned with water.

### Cleaning the air filters (Once every 2 weeks)

- 1** **Open the front panel and remove the two air filters.**  
Hold the tab, lift up slightly, then pull down.

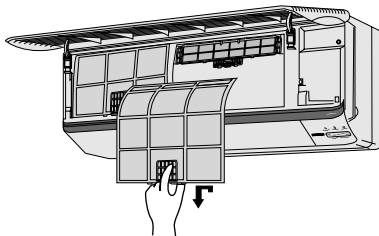

- 2** **Remove dirt using a vacuum cleaner.**  
For heavy dirt, wash with water and dry well (away from direct sunlight) before replacing.

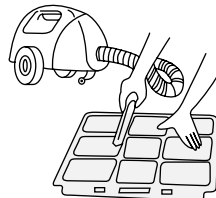

- 3** **Replace the air filter.**  
Be sure the "FRONT" mark is facing you.

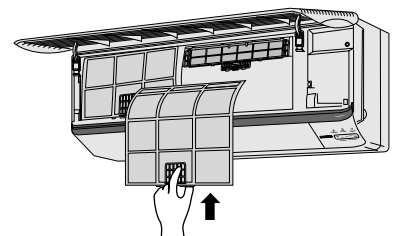

- 4** **Close the front panel.**

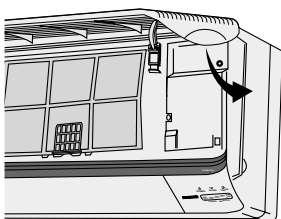

### Recommendation

If the unit is operated in a dusty environment, clean the filters every two weeks. Continued use with dirty filters reduces cooling and heating efficiency.

### Damaged air filter

Consult the nearest authorized dealer.  
Part No. CWD00240

**Cleaning the front panel (Must be removed before washing)**



**Caution**

- Stand on a flat surface when removing the front panel.
- Do not touch the indoor unit's metal portions after removing the front panel.
- Do not leave water on the panel after cleaning. Dry thoroughly to prevent electric shock.

**■ Removing the front panel**

- 1** Raise the front panel to its full extent.
- 2** Slide the two tabs (left and right) to the UNLOCK position.
- 3** Raise up the front panel to a position slightly higher than horizontal and pull to remove.

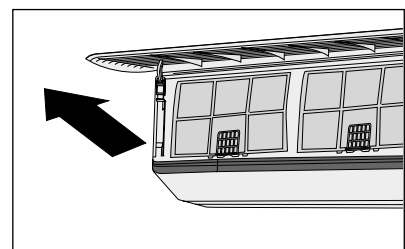
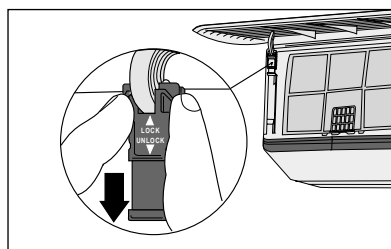
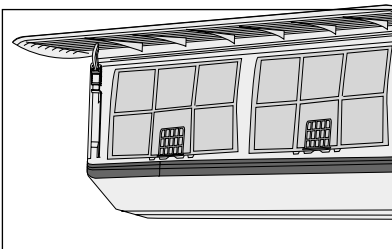

**■ Cleaning the front panel**

- Gently wash with water and a sponge. (Do not use a scrubbing brush or other hard cleaning aids.)
- Do not press the front panel too hard when washing. (Excess pressure may damage the panel.)
- When cleaning with kitchen cleaning fluids (neutral detergents), rinse thoroughly. (Do not use non-neutral detergents.)
- Do not dry the front panel in direct sunlight. (Exposure to direct sunlight may discolor or disfigure the panel.)

**■ Fixing the front panel**

- 1** Raise the front panel horizontally, match the protruding portion on the indoor unit to the fulcrum and push into place.
- 2** Slide the two tabs up to the LOCK position. **Note:** If the tabs are left in the UNLOCK position, the front panel will not close.

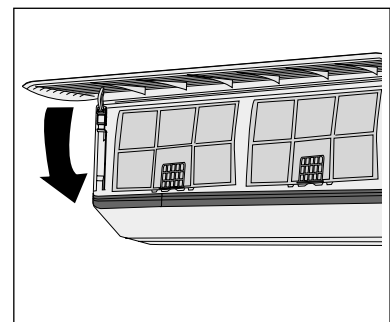
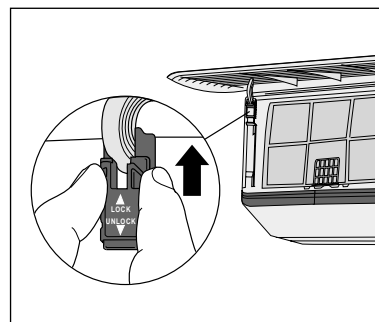
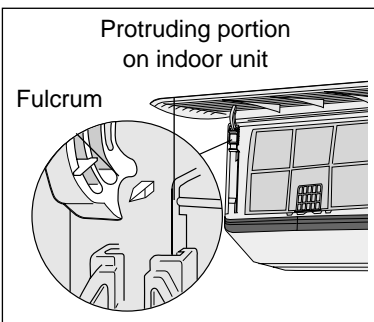

- If the panel does not close completely, check the tab positions and try again.



## Care and Maintenance

### Replacing the air purifying filters (Once every 3 months)

#### ■ Replacing the air purifying filters

- Do not reuse dirty filters. Consult the nearest authorized dealer. Air purifying filter No. CZ-SFD50N.
- These filters function effectively for no longer than three months.
- If the air conditioner operates with dirty filters:
  - Air is not purified.
  - Cooling and heating capacity decrease.
  - Foul odours are emitted.
- Note:  
Catechin is natural brown element. The filter is coated with catechin in order to prevent the growth of bacteria and viruses.

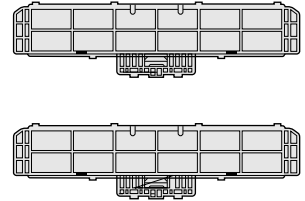

#### ■ Removing the air purifying filters

**1** Raise the front panel to its full extent.

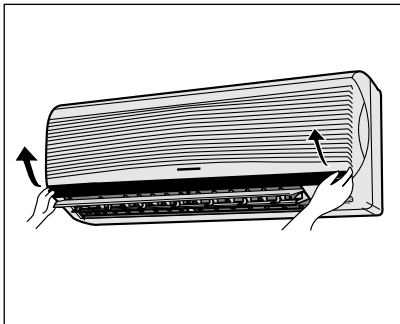

**2** Remove the two air filters.

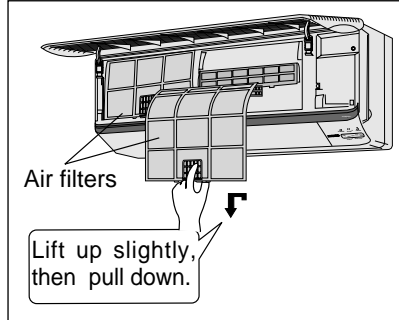

**3** Hold the tabs of the air purifying filters and pull.

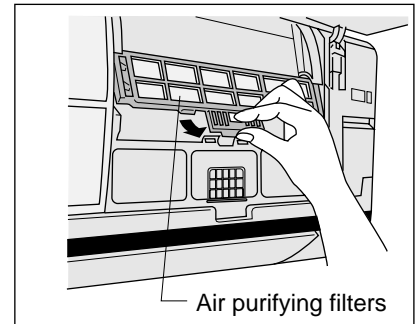

#### ■ Re-installing the air purifying filters

**1** Open the filter frame to insert the new filters.

Note:

- Deodorizing Filter (Black in colour)
- Catechin Air Purifying Filter (Brown in colour)

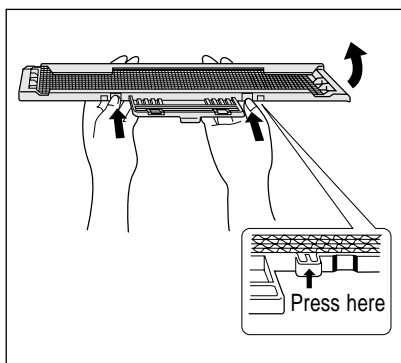

**2** Insert the new air purifying filters. (Be sure the "FRONT" mark is facing you).

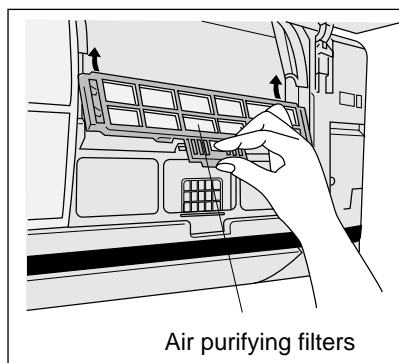

**3** Push until you hear a click.

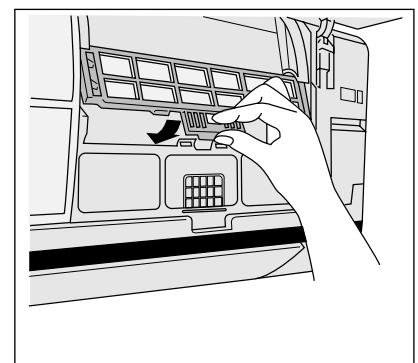

- Close the front panel after reinstalling the air filters.



## Caution

### ■ Do not ignore a damaged installation rack.

A damaged rack may fall and cause injury. Consult an authorized dealer.

## Pre-season inspection

### ■ Is the discharge air cold (warm)?

Operation is normal if, 15 minutes after the start of operation, the temperature difference between the air intake and outlet vents is 8°C or above for cooling and 14°C or above for heating.

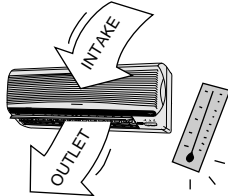

### ■ Are the air intake or outlet vents obstructed?

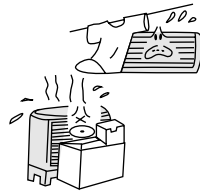

### ■ Are the remote control batteries dead?

If the remote control display flashes, replace the batteries. (page 9)

## When the air conditioner is not used for an extended period of time

**1** To dry the internal parts of indoor unit, operate the unit for 2 ~ 3 hours using Fan operation.

**2** Turn off the Power Supply and remove the power supply plug.

**Note :** If the unit is not switched off by the remote control, it will operate when you plug in (because a Auto Restart Control is provided).

**3** Remove the remote control batteries.

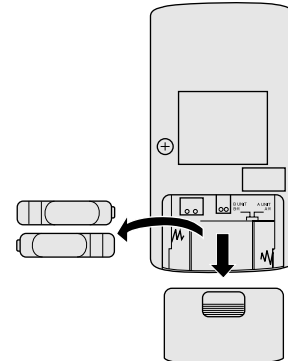

## Recommended inspection



- The unit will become dirty after use over several seasons, reducing performance.
- Depending on the operation condition, a dirty unit may produce foul odours and dust may pollute the dehumidifying drainage.

Seasonal inspections are recommended, in addition to regular cleaning. Consult an authorized dealer.

## Troubleshooting

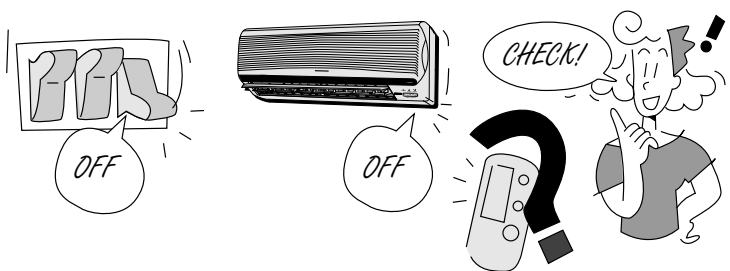
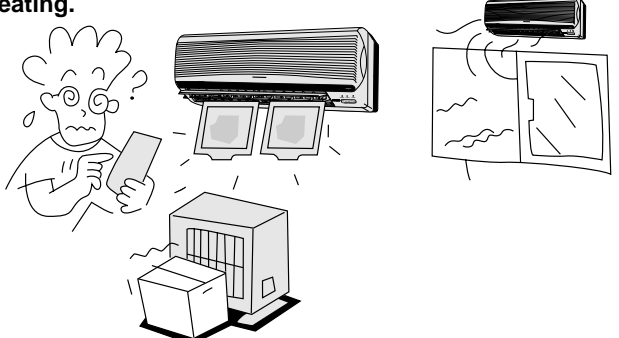
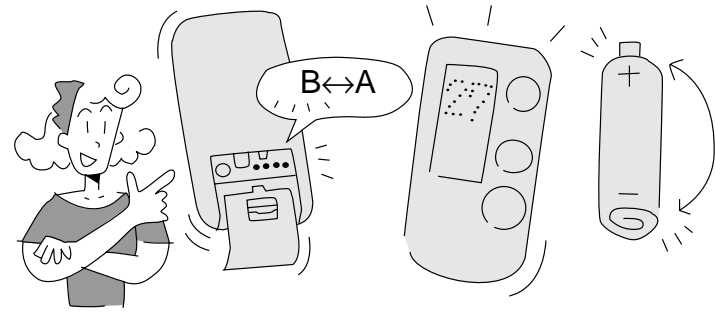
(Before calling your dealer, refer to the checklist)

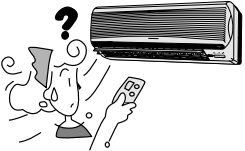
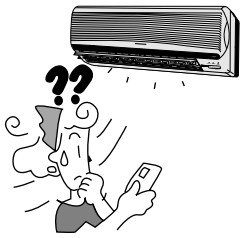
Problem?	Check
<p><b>The unit does not operate</b></p>	<ul style="list-style-type: none"> <li>■ Has a circuit breaker been tripped or a fuse blown?</li> <li>■ Is the power supply plug disconnected from the outlet?</li> <li>■ Is the Timer being used correctly (page 14)?</li> </ul> 
<p><b>The unit does not cool or heat effectively</b></p>	<ul style="list-style-type: none"> <li>■ Has the temperature been set correctly (page 10)?</li> <li>■ Are the air filters dirty (page 18)?</li> <li>■ Are the air intake or outlet vents blocked?</li> <li>■ Are all the windows and doors closed?</li> <li>※ Measure the temperature difference. Operation is normal if, 15 minutes after the start of operation, the temperature difference between the air intake and outlet vents is 8°C or above for cooling and 14°C or above for heating.</li> </ul> 
<p><b>The unit does not receive remote control signals, or the remote control display is weak or non-existent</b></p>	<ul style="list-style-type: none"> <li>■ Is the signal switch set to "B" (page 7)?</li> <li>■ Are the batteries weak (page 9)?</li> <li>■ Have the batteries been inserted with the ⊕ and ⊖ poles in the correct position?</li> </ul> 

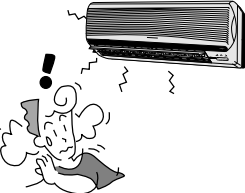
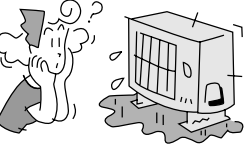
Problem?	Reason
<p><b>Air is not discharged immediately</b></p>	<ul style="list-style-type: none"> <li>● <b>At Cooling • Soft Dry (auto Fan Speed)</b> Air will not be discharged for approximately 40 seconds. The unit is designed to prevent tobacco, cooking and body odors from being discharged together with the cool air.</li> <li>● <b>At Heating (POWER LED blinks)</b> This is to prevent cold air from blowing out. Please wait.</li> </ul> 
<p><b>Operation stops suddenly</b></p>	<ul style="list-style-type: none"> <li>● <b>At Cooling • Soft Dry (auto Fan Speed)</b> The indoor fan repeatedly stops for 60 seconds and operates for 30 seconds to check the indoor temperature. Whenever the temperature reaches the setting temperature, operation starts again.</li> <li>● <b>At Heating (POWER LED blinks)</b> When the outdoor temperature is low and humidity is high, frost accumulates on the outdoor unit. The POWER LED blinks when the unit is melting the frost. (Please wait as defrosting may take up to 10 minutes.)</li> </ul> 
<p><b>Fog is blowing out from the unit</b></p>	<ul style="list-style-type: none"> <li>● This occurs when the airflow from the air conditioner cools the room.</li> </ul> 
<p><b>There is a noise</b></p>	<ul style="list-style-type: none"> <li>● A 'passt' sound is heard during defrosting or when the air conditioner operation has been stopped. This is caused by the refrigerant inside the air conditioner flowing in the opposite direction.</li> <li>● The air conditioner will expand or contract due to changes in temperature, causing a cracking sound.</li> <li>● The sound of water flowing is caused by the refrigerant flowing inside the unit.</li> </ul> 
<p><b>The outdoor unit gives off water and steam</b></p>	<ul style="list-style-type: none"> <li>● When defrosting, the frost melts and changes to water and steam.</li> </ul> 

# Is There a Problem?

Call the dealer immediately

Call the dealer immediately if any of the following occurs.

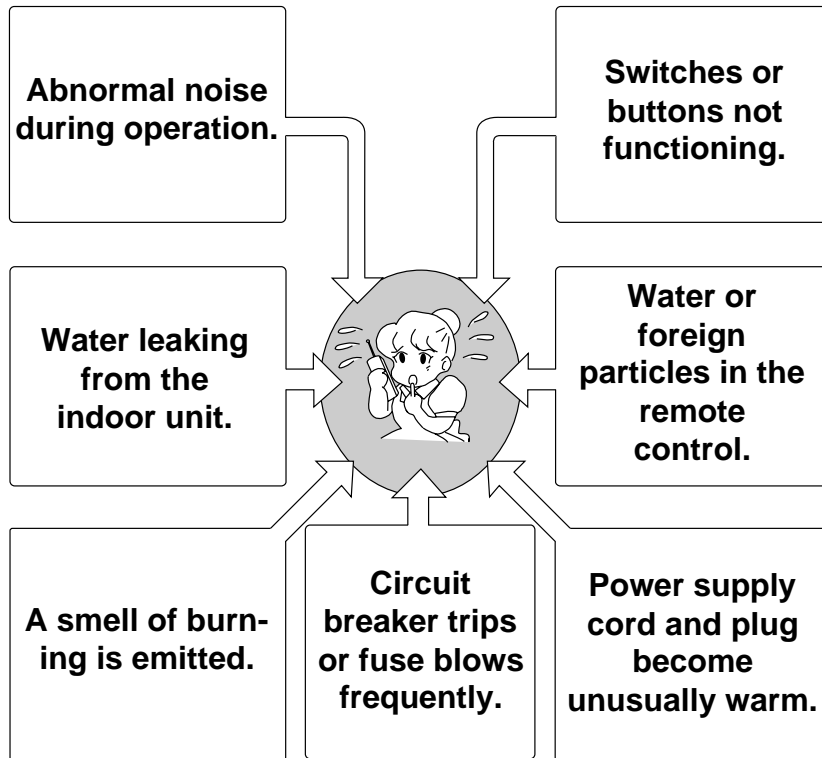

Turn off the Power Supply and remove the power supply plug.

## ■ The Timer LED blinks and 3 characters are displayed.

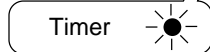
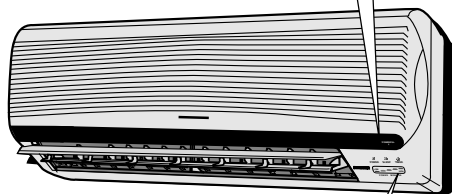
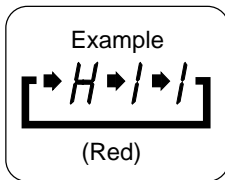

- Blinking indicates an abnormality. Check the display and consult an authorized dealer.
- After checking the display, turn off the power supply and remove the power supply plug.
- Depending on which 3 characters are displayed, temporary operation may be possible.

Characters allowing temporary operation	Possible temporary operations	Description of operation
[*H*2*3]	Cooling	Emergency operation with limited functions. (The Timer LED continues to blink.)
[*H*2*7]	Heating	
[*H*2*8]	Cooling	

### ● Temporary operation

1. Press the **(MODE)** button and select Heating or Cooling.
2. Press the operation OFF/ON button ('beep! beep! beep! beep!' sound is heard).
  - ※ Use this operation temporarily, until repairs can be made.

## Helpful Information

### Remote control fails to function

If the remote control fails to function or has been misplaced, carry out auto operation. Auto operation settings are automatic; the temperature cannot be adjusted.

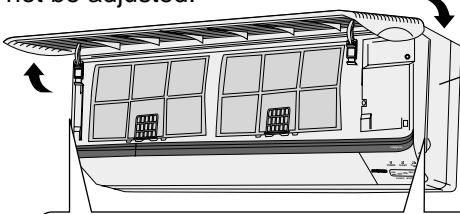

Hold the two panel openers of the front panel and pull. (Replace after operation starts.)

#### 1 Turn the Power Supply to ON

#### 2 Press the Auto Operation button

The POWER LED blinks until the operation mode is selected.

#### ■ To cancel Auto Operation

Press the Auto Operation button again (POWER LED lights off).

AUTO OFF/ON

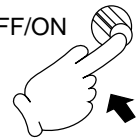

### When there is a power failure

#### ■ Power failure during operation Auto Restart Control

- If there is a power failure, operation will be automatically restarted under the previous operation mode and airflow direction when the power is resumed as the operation is not stopped by remote control.
- When the operation restarts, the outdoor unit will operate only after 3~4 minutes.

#### ● Power failure after the Timer has been set

The Timer setting is cancelled. (Main unit's Timer LED is extinguished.) Once power is restored, reset the Timer.

(Ex) Power failure after the ON-Timer has been set.

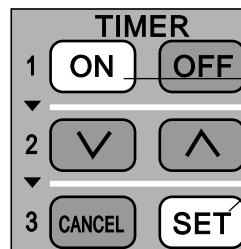

1 Press **ON** Button

2 Press **SET** Button

(Indoor unit's Timer LED lights up.)

### Thunder and lightning

This air conditioner is equipped with a built-in surge protective device. However, in order to further protect your air conditioner from being damaged by abnormally strong lightning activity, you may switch off the main power supply and unplug from power socket.

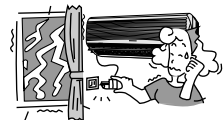

### Voltage fluctuation

The outdoor unit stops operation frequently due to a fluctuation in the voltage. Consult your dealer.



## Warning

- 1) This appliance must be earthed.
- 2) If the supply cord is damaged or need to be replaced, it must be replaced by the manufacturer or its service agent or a similarly qualified person in order to avoid a hazard.
- 3) Remove power plug or disconnect from the mains before servicing this appliance.
- 4) Do not repair by yourself.  
In case of malfunction of this appliance, do not repair by yourself.  
Contact to the sales dealer or service dealer for a repair.
- 5) Do not use in an explosive atmosphere.  
Do not use this appliance in a potentially explosive atmosphere.
- 6) Turn off the power (Isolation from main power supply).  
Pull off the power plug from the receptacle, or switch off the breaker, or switch off the power disconnecting mean to isolate the equipment from the main power supply in case of an emergency.



## Caution

DISCONNECT THE MAINS PLUG FROM THE SUPPLY SOCKET WHEN NOT IN USE, WHERE SUPPLY CONNECTION IS VIA MAINS PLUG.

Airborne noise.

A-weighted sound pressure level of this appliance is less than 70dB (A) under the JIS C 9612 test conditions.

Maximum cooling operation  
1 m from the unit

## IMPORTANT

The wires in this mains lead are coloured in accordance with the following code:

Green and Yellow	:	Earth
Blue	:	Neutral
Brown	:	Live

“As the colours of the wires in the mains lead of this appliance may not correspond with the coloured markings identifying the terminals in your plug, proceed as follows:

The wire which is coloured green and yellow must be connected to the terminal in the plug which is marked by the letter E or by safety earth symbol  $\oplus$  or coloured green or green and yellow.

The wire which is coloured blue must be connected to the terminal which is marked with letter N or coloured black.

The wire which is coloured brown must be connected to the terminal which is marked with letter L or coloured red.”

# 10 Installation Instructions

Required tools for Installation Works			
1. Phillips screw driver	5. Spanner	9. Gas leak detector	13. Multimeter
2. Level gauge	6. Pipe cutter	10. Measuring tape	14. Torque wrench 18 N.m (1.8 kgf.m) 42 N.m (4.2 kgf.m) 55 N.m (5.5 kgf.m)
3. Electric drill, hole core drill ( $\phi 70$ mm)	7. Reamer	11. Thermometer	15. Vacuum pump
4. Hexagonal wrench (4 mm)	8. Knife	12. Megameter	16. Gauge manifold

## 10.1. Safety Precautions

- Read this following "SAFETY PRECAUTIONS" carefully before installation.
- Electrical work must be installed by all licensed electrician. Be sure to use the correct rating of the power plug and main circuit for the model to be installed.
- The caution items stated here must be followed because these important contents are related to safety. The meaning of each indication used is as below.

Incorrect installation due to ignoring of the instruction will cause harm or damage, and the seriousness is classified by the following indication.



 <b>WARNING</b>	This indication shows the possibility of causing death or serious injury.
---	---

 <b>CAUTION</b>	This indication shows the possibility of causing injury or damage to properties only.
--	---

The items to be followed are classified by the symbols:

	Symbol with background white denotes item that is PROHIBITED from piping.
---	---

- Carry out test running to confirm that no abnormality occurs after the installation. Then, explain to user the operation, care and maintenance as stated in instruction. Please remind the customer to keep the operating instructions for future reference.

 <b>WARNING</b>	
1. Engage dealer or specialist for installation. If installation done by the user is defective, it will cause water leakage, electrical shock or fire.	
2. Install according to this installation instruction strictly. If installation is defective, it will cause water leakage, electrical shock or fire.	
3. Use the attached accessories parts and specified parts for installation. Otherwise, it will cause the set to fall, water leakage, fire or electrical shock.	
4. Install at a strong and firm location which is able to withstand the set's weight. If the strength is not enough or installation is not properly done, the set will drop and cause injury.	
5. For electrical work, follow the local national wiring standard, regulation and this installation instruction. An independent circuit and single outlet must be used. If electrical circuit capacity is not enough or defect found in electrical work, it will cause electrical shock or fire.	
6. Use the specified cable (1.5 mm <sup>2</sup> ) and connect tightly for indoor/outdoor connection. Connect tightly and clamp the cable so that no external force will be acted on the terminal. If connection or fixing is not perfect, it will cause heat-up or fire at the connection.	
7. Wire routing must be properly arranged so that control board cover is fixed properly. If control board cover is not fixed perfectly, it will cause heat-up at connection point of terminal, fire or electrical shock.	
8. When carrying out piping connection, take care not to let air or other substances other than the specified refrigerant go into refrigeration cycle. Otherwise, it will cause lower capacity, abnormal high pressure in the refrigerant cycle, explosion and injury.	
9. Do not damage or use unspecified power supply cord. Otherwise, it will cause fire or electrical shock.	
10. Do not modify the length of the power supply cord or use of the extension cord, and do not share the single outlet with other electrical appliances. Otherwise, it will cause fire or electrical shock.	









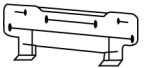

**CAUTION**

- |  |   |
|--|---|
| 1. Grounding is necessary. It may cause electrical shock if grounding is not perfect.  |   |
| 2. Do not install the unit at place where leakage of flammable gas may occur. In case gas leaks and accumulates at surrounding of the unit, it may cause fire. |  |
| 3. Carry out drainage piping as mentioned in installation instructions. If drainage is not perfect, water may enter the room and damage the furniture.         |   |

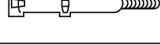
**ATTENTION**

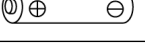
- |   |
|---|
| 1. Selection of the installation location.<br>Select a installation location which is rigid and strong enough to support or hold the unit, and select a location for easy maintenance.  |
| 2. Power supply connection to the room air conditioner.<br>Connect the power supply cord of the room air conditioner to the mains using one of the following method.<br>Power supply point shall be the place where there is ease for access for the power disconnection in case of emergency. In some countries, permanent connection of this room air conditioner to the power supply is prohibited. <ol style="list-style-type: none"> <li>1. Power supply connection to the receptacle using a power plug. Use an approved 16A power plug with earth pin for the connection to the receptacle.</li> <li>2. Power supply connection to a circuit breaker for the permanent connection. Use an approved 16A circuit breaker for the permanent connection. It must be a double pole switch with a minimum 3 mm contact gap.</li> </ol> |
| 3. Do not release refrigerant.<br>Do not release refrigerant during piping work for installation, re-installation and during repairing a refrigeration parts. Take care of the liquid refrigerant, it may cause frostbite.  |
| 4. Installation work.<br>It may need two people to carry out the installation work.   |
| 5. Do not install this appliance in a laundry room or other location where water may drip from the ceiling, etc.  |

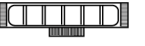
**Attached accessories**

No.	Accessories part	Qty.	No.	Accessories part	Qty.
1	Installation plate 	1	6	Drain elbow 	1
2	Installation plate fixing screw 	6	7	Band 	1
3	Remote control 	1	8	Remote Control holder 	1
4	Battery 	2	9	Remote Control holder fixing screw 	2
5	Air purifying filter 	2			

Applicable piping kit  
CZ-3F5, 7AEN  
CZ-4F5, 7, 10AN

**SELECT THE BEST LOCATION**

**INDOOR UNIT**

- There should not be any heat source or steam near the unit.
- There should not be any obstacles blocking the air circulation.
- A place where air circulation in the room is good.
- A place where drainage can be easily done.
- A place where noise prevention is taken into consideration.
- Do not install the unit near the door way.
- Ensure the spaces indicated by arrows from the wall, ceiling, or other obstacles.
- Indoor unit of this room air conditioner shall be installed on the wall in a height of at least 2.3 m.

**OUTDOOR UNIT**

- If an awning is built over the unit to prevent direct sunlight or rain, be careful that heat radiation from the condenser is not obstructed.
- There should not be any animal or plant which could be affected by hot air discharged.
- Keep the spaces indicated by arrows from wall, ceiling, fence or other obstacles.
- Do not place any obstacles which may cause a short circuit of the discharged air.

Model	Piping size		Common Length (m)	Max. Elevation (m)	Max. Piping Length (m)
	Gas	Liquid			
G95KE	3/8"	1/4"	5	5	7
G125KE	1/2"	1/4"	5	5	7

**Indoor/Outdoor unit installation diagram**

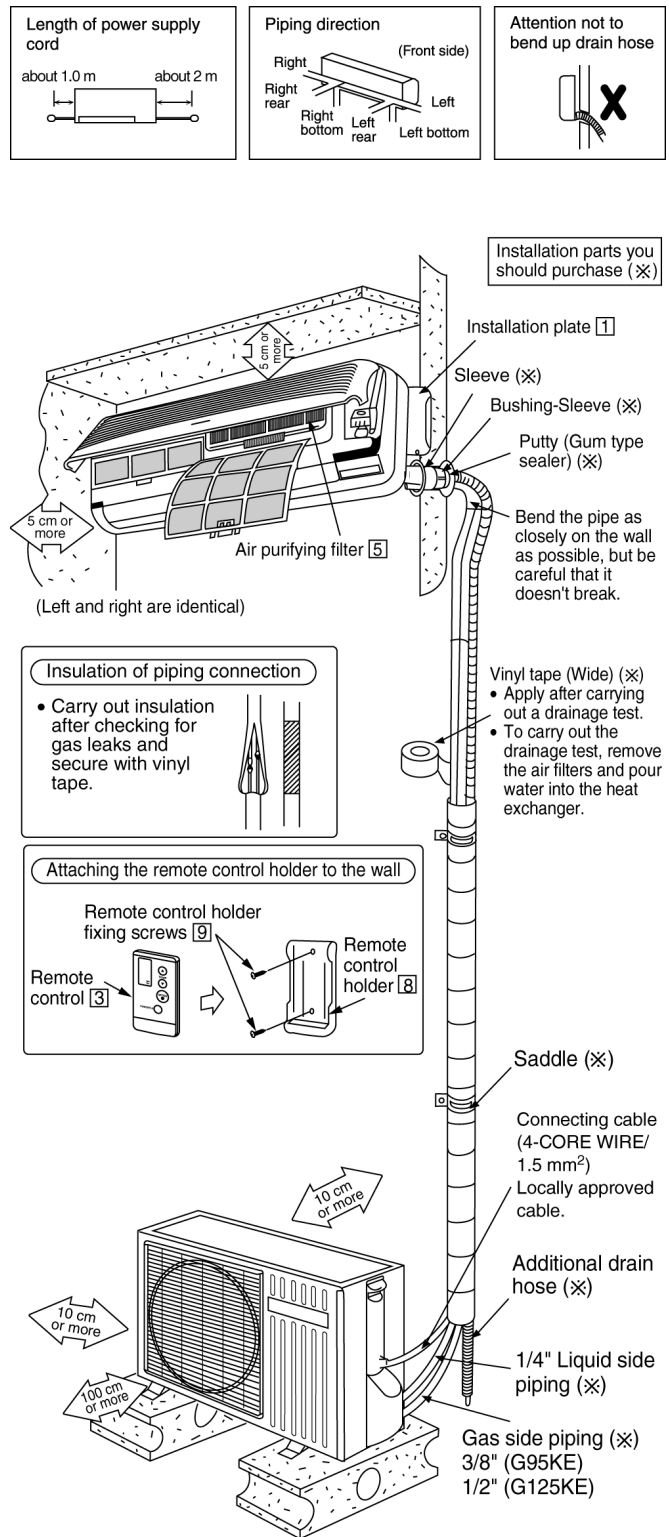

• This illustration is for explanation purposes only. The indoor unit will actually face a different way.

## 10.2. INDOOR UNIT

### 10.2.1. SELECT THE BEST LOCATION (Refer to “Select the best location” section)

### 10.2.2. HOW TO FIX INSTALLATION PLATE

The mounting wall is strong and solid enough to prevent it from the vibration.

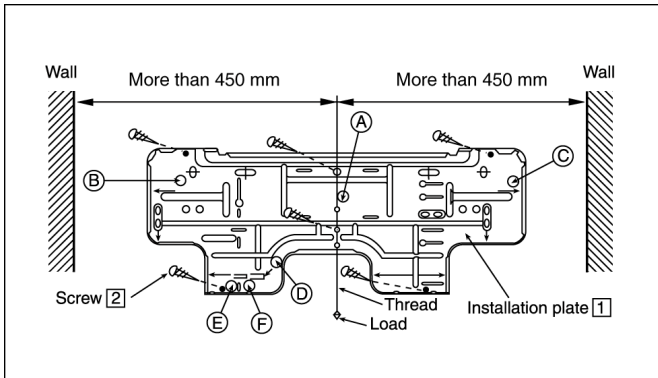

- (A) : Unit centre should be at more than 450 mm at right and left of the wall.  
The height should be more than 195 mm from the ceiling.
- (B) : From installation plate end to unit left side end is 50 mm.
- (C) : From installation plate end to unit right side end is 50 mm.
- (D) : Connecting cable should be about 750 mm from this line.  
(Only for left rear piping)
- (E) : For left side piping, piping connection for liquid should be here.
- (F) : For left side piping, piping connection for gas should be here.

1. Mount the installation plate on the wall with six screws.  
(If mounting the unit on the concrete wall consider using anchor bolts.)

- Always mount the installation plate horizontally by aligning the marking-off line with the thread and using a level gauge.

2. Drill the piping plate hole with  $\phi 70$  mm hole-core drill.

- Line according to the arrows marked on the lower left and right side of the installation plate. The meeting point of the extended line is the centre of the hole.
- Drill the piping hole at either the right or the left and the hole should be slightly slanted to the outdoor side.

### 10.2.3. TO DRILL A HOLE IN THE WALL AND INSTALL A SLEEVE OF PIPING

1. Insert the piping sleeve to the hole.
2. Fix the bushing to the sleeve.
3. Cut the sleeve until it extrudes about 15 mm from the wall.

#### Caution

When the wall is hollow, please be sure to use the sleeve for tube ass'y to prevent dangers caused by mice biting the indoor/outdoor connecting cable.

4. Finish by sealing the sleeve with putty or caulking compound at the final stage.

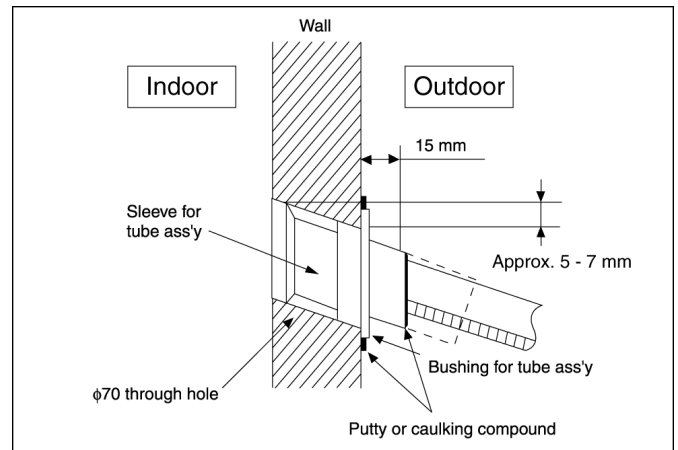

### 10.2.4. INDOOR UNIT INSTALLATION

#### 1. For the right rear piping

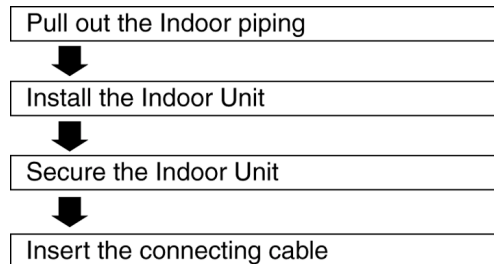

#### 2. For the right and right bottom piping

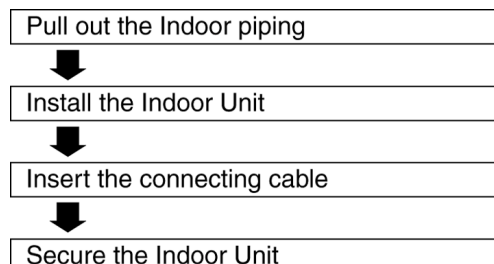

### 3. For the embedded piping

- Replace the drain hose
- ↓
- Bend the embedded piping
  - Use a spring bender or equivalent to bend the piping so that the piping is not crushed.
- ↓
- Install the Indoor Unit
- ↓
- Cut and flare the embedded piping
  - When determining the dimension of the piping, slide the unit all the way to the left on the installation plate.
  - Refer to the section "Cutting and flaring the piping".
- ↓
- Pull the connecting cable into Indoor Unit
  - The inside and outside connecting cable can be connected without removing the front grille.
- ↓
- Connect the piping
  - Please refer to "Connecting the piping" column in outdoor unit section. (Below steps are done after connecting the outdoor piping and gas-leakage confirmation.)
- ↓
- Insulate and finish the piping
  - Please refer to "Piping and finishing" column of outdoor section and "Insulation of piping connections" column as mentioned in Indoor/Outdoor Unit Installation.
- ↓
- Install clamping cover of piping
  - Refer to figure on next page.
- ↓
- Secure the Indoor Unit

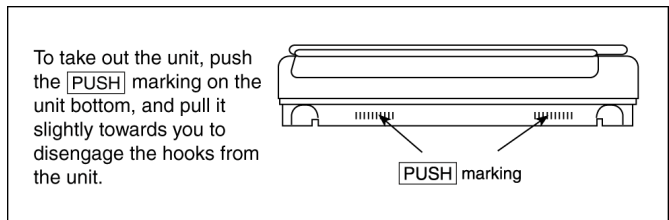
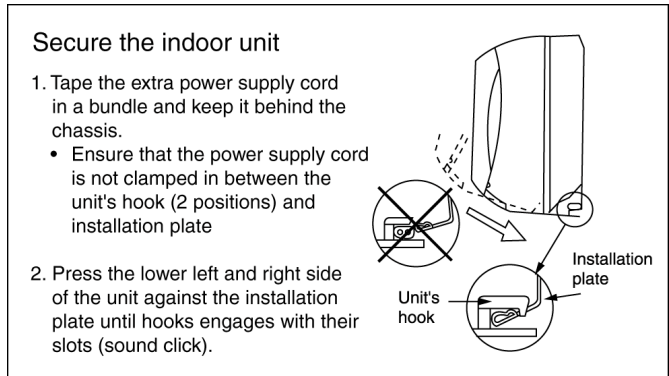
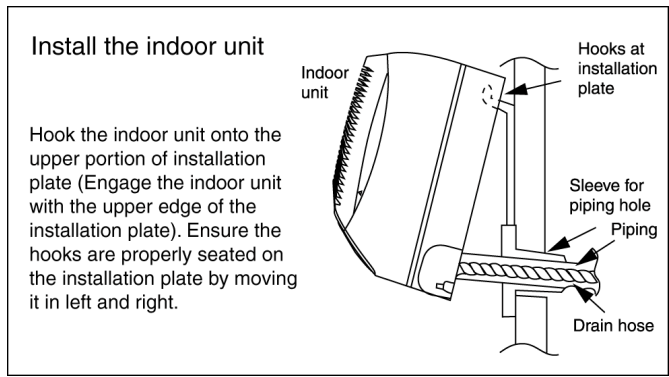
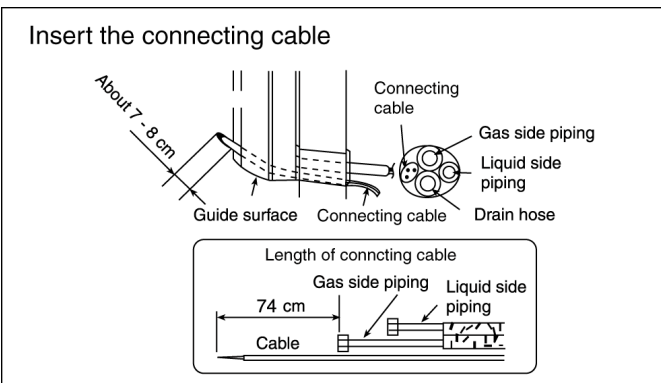
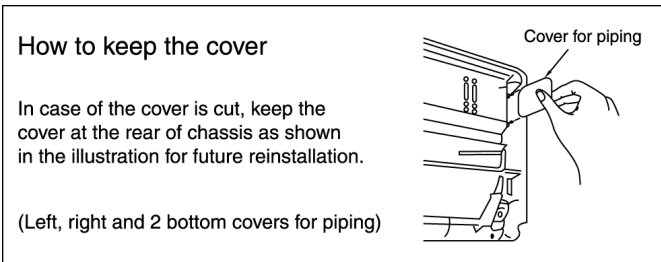
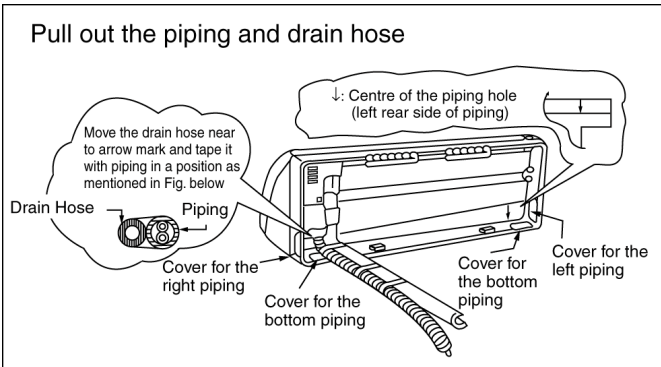

(This can be used for left rear piping and left bottom piping also.)

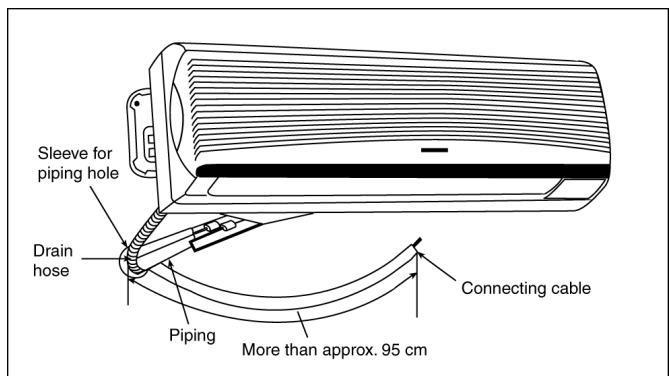
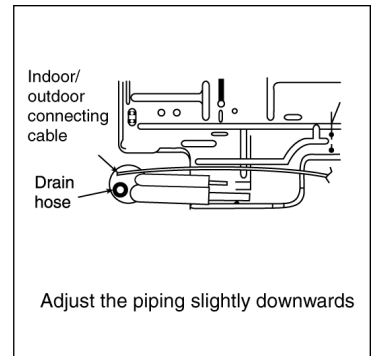
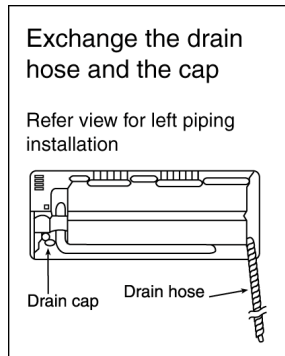

- How to pull the piping and drain hose out, in case of the embedded piping.

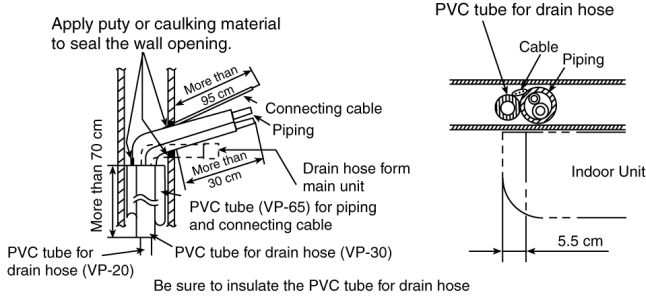

### ATTACHMENT OF THE PIPING BAND

- For the right rear piping, it is not necessary to use piping band. The piping band can be attached when the extension flare pipe is used or when doing the piping work (under condition as shown in the diagram below) on the floor.
- The location to attach the piping band change according to the direction of the piping. Press the band knot to the hole in order to fix the band as shown in diagram below.

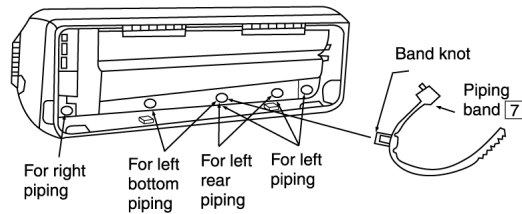

- Tighten the band so that the cable and the piping are secure. Be sure to cut any excess from the piping band (failure to cut away the excess piping band may produce abnormal noise during operation of condensation).

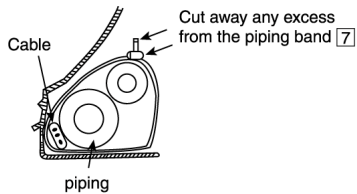

- In case of left piping how to insert the connecting cable and drain hose.

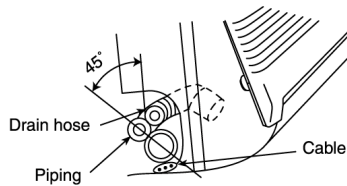

(For the right piping, follow the same procedure)

## 10.2.5. CONNECT THE CABLE TO THE INDOOR UNIT

1. The inside and outside connecting cable can be connected without removing the front grille.
2. Connecting cable between indoor unit and outdoor unit shall be approved polychloroprene sheathed  $4 \times 1.5 \text{ mm}^2$  flexible cord, type designation H05 RN-F or heavier cord.
  - Ensure the color of wires of outdoor unit and the terminal Nos. are the same to the Indoor's respectively.
  - Earth lead wire shall be longer than the other lead wires as shown in the figure for the electrical safety in case of the slipping out of the cord from the anchorage.

Terminals on the indoor unit	1	2	3	
Color of wires				
Terminals on the outdoor unit	1	2	3	

- Secure the cable onto the control board with the holder (clammer).

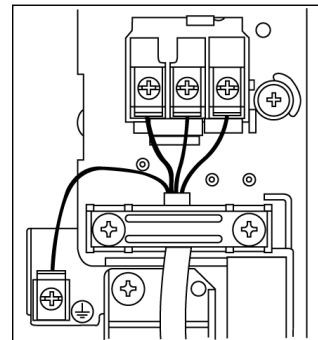

### INSTALLATION OF AIR PURIFYING FILTERS

1. Open the front panel.
2. Remove the air filters.
3. Hold the purifying filters by their tabs and install as shown in the illustration at below.

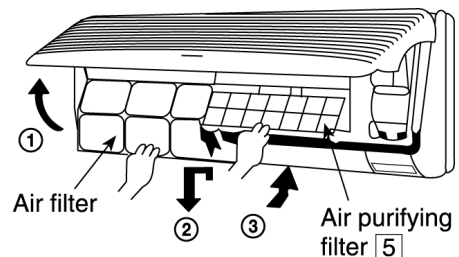

## HOW TO TAKE OUT FRONT GRILLE

Please follow below steps to take out front grille if necessary such as when servicing.

1. Set the vertical airflow direction louver to the horizontal position.
2. Slide down the two caps on the front grille as shown in the illustration below, and then remove the two mounting screws.
3. Pull the lower section of the front grille towards you to remove the front grille.

When reinstalling the front grille, first set the vertical airflow direction louver to the horizontal position and then carry out above steps 2 - 3 in the reverse order.

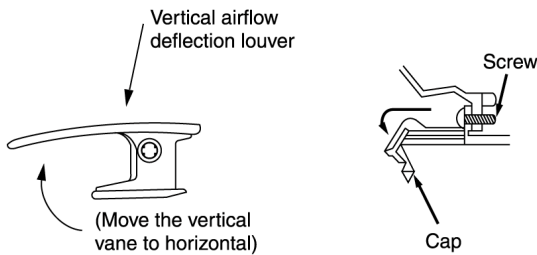

## AUTO SWITCH OPERATION

The below operations will be performed by pressing the "AUTO" switch.

### 1. AUTO OPERATION MODE

The Auto operation will be activated immediately once the Auto Switch is pressed.

### 2. TEST RUN OPERATION (FOR PUMP DOWN/SERVICING PURPOSE)

The Test Run operation will be activated if the Auto Switch is pressed continuously for more than 5 sec. to below 10 sec.. A "beep" sound will occur at the fifth sec., in order to identify the starting of Test Run operation

### 3. REMOTE CONTROLLER RECEIVING SOUND ON/OFF

The ON/OFF of Remote Controller receiving sound can be change over by pressing the "AUTO" Switch continuously for 10 sec. and above. A "beep", "beep" sound will occur at the tenth sec., in order to indicate the "ON/OFF" change over of remote control receiving sound.

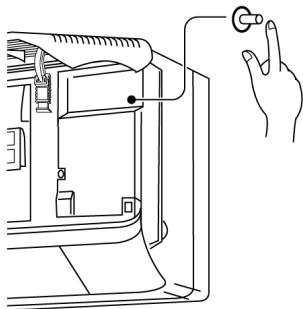

## 10.3. OUTDOOR UNIT

### 10.3.1. SELECT THE BEST LOCATION (Refer to "Select the best location" section)

### 10.3.2. INSTALL THE OUTDOOR UNIT

- After selecting the best location, start installation according to Indoor/Outdoor Unit Installation Diagram.

1. Fix the unit on concrete or rigid frame firmly and horizontally by bolt nut. ( $\phi 10$  mm).
2. When installing at roof, please consider strong wind and earthquake. Please fasten the installation stand firmly with bolt or nails.

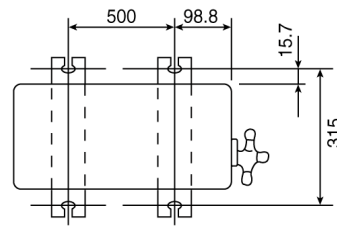

### 10.3.3. CONNECTING THE PIPING

#### Connecting the Piping to Indoor Unit

Please make flare after inserting flare nut (locate at joint portion of tube assembly) onto the copper pipe. (In case of using piping)

Connect the piping

- Align the center of piping and sufficiently tighten the flare nut with fingers.
- Further tighten the flare nut with torque wrench in specified torque as stated in the table.

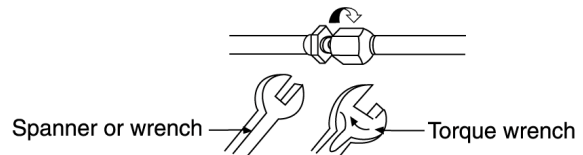

MODEL	Piping size (Torque)	
	Gas	Liquid
G95KE	3/8" (42 N.m)	1/4" (18 N.m)
G125KE	1/2" (55 N.m)	1/4" (18 N.m)

#### Connecting the Piping to Outdoor Unit

Decide piping length and then cut by using pipe cutter. Remove burrs from cut edge. Make flare after inserting the flare nut (located at valve) onto the copper pipe.

Align center of piping to valves and then tighten with torque wrench to the specified torque as stated in the table.

## CUTTING AND FLARING THE PIPING

1. Please cut using pipe cutter and then remove the burrs.
2. Remove the burrs by using reamer. If burrs is not removed, gas leakage may be caused.  
Turn the piping and down to avoid the metal powder entering the pipe.
3. Please make flare after inserting the flare nut onto the copper pipes.

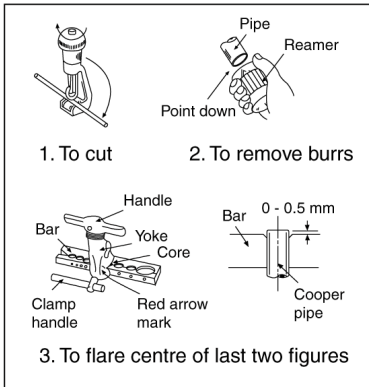

### ■ Improper flaring ■

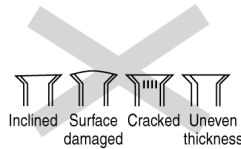

When properly flared, the internal surface of the flare will evenly shine and be of even thickness. Since the flare part comes into contact with the connectors, carefully check the flare finish.

Note: BE SURE TO TAKE THIS PROCEDURE IN ORDER TO AVOID REFRIGERANT GAS LEAKAGE.

5. Disconnect the charging hose from the vacuum pump and from the service port of the 3-way valve.
6. Tighten the service port caps of the 3-way valve at torque of 18 N.m with a torque wrench.
7. Remove the valve caps of both of the 2-way valve and 3-way valve. Position both of the valves to "OPEN" using a hexagonal wrench (4 mm).
8. Mount valve caps onto the 2-way valve and the 3-way valve.
  - Be sure to check for gas leakage.

### CAUTION

- If gauge needle does not move from 0 cmHg (0 MPa) to -76 cmHg (-0.1 MPa), in step 3 above take the following measure:
- If the leak stops when the piping connections are tightened further, continue working from step 3.
- If the leak does not stop when the connections are retightened, repair the location of leak.
- Do not release refrigerant during piping work for installation and re-installation. Take care of the liquid refrigerant, it may cause frostbite.

## 10.3.4. EVACUATION OF THE EQUIPMENT

WHEN INSTALLING AND AIR CONDITIONER, BE SURE TO EVACUATE THE AIR INSIDE THE INDOOR UNIT AND PIPES in the following procedure.

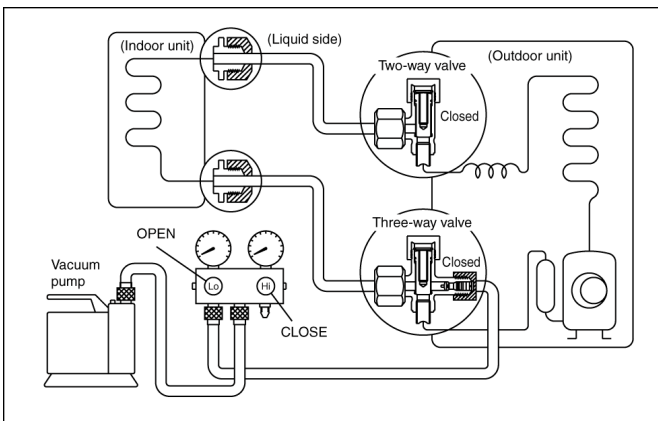

1. Connect a charging hose with a push pin to the Low and High side of a charging set and the service port of the 3-way valve.
  - Be sure to connect the end of the charging hose with the push pin to the service port.
2. Connect the center hose of the charging set to a vacuum pump.
3. Turn on the power switch of the vacuum pump and make sure that the needle in the gauge moves from 0 cmHg (0 MPa) to -76 cmHg (-0.1 MPa). Then evacuate the air approximately ten minutes.
4. Close the valve of both the Low and High sides of the charging set and turn off the vacuum pump. Make sure that the needle in the gauge does not move after approximately five minutes.

## 10.3.5. CONNECT THE CABLE TO THE OUTDOOR UNIT

1. Remove the control board cover from the unit by loosening the screw.
2. Connecting cable between indoor unit and outdoor unit shall be approved polychloroprene sheathed  $4 \times 1.5 \text{ mm}^2$  flexible cord, type designation H05 RN-F or heavier cord.

Terminals on the indoor unit	1	2	3	
Color of wires				
Terminals on the outdoor unit	1	2	3	

3. Secure the cable onto the control board with the holder (clamper).
4. Attach the control board cover back to the original position with the screw.

## 10.3.6. PIPE INSULATION

1. Please carry out insulation at pipe connection portion as mentioned in Indoor/Outdoor Unit Installation Diagram. Please wrap the insulated piping end to prevent water from going inside the piping.
2. If drain hose or connecting piping is in the room (where dew may form), please increase the insulation by using POLY-E FOAM with thickness 6 mm or above.

### DISPOSAL OF OUTDOOR UNIT DRAIN WATER

- If a drain elbow is used, the unit should be placed on a stand which is taller than 3 cm.
- If the unit is used in an area where temperature falls below 0°C for 2 or 3 days in succession, it is recommended not to use a drain elbow, for the drain water freezes and the fan will not rotate.

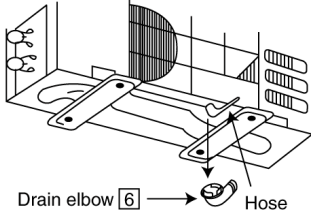

Install the hose at an angle so that the water smoothly flows out.

### CHECK THE DRAINAGE

- Open front panel and remove air filters.  
(Drainage checking can be carried out without removing the front grille.)
- Pour a glass of water into the drain tray-styrofoam.
- Ensure that water flows out from drain hose of the indoor unit.

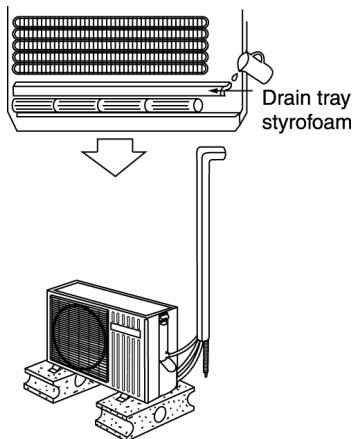

### EVALUATION OF THE PERFORMANCE

- Operate the unit at cooling operation mode for fifteen minutes or more.
- Measure the temperature of the intake and discharge air.
- Ensure the difference between the intake temperature and the discharge is more than 8°C.

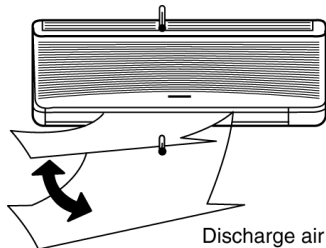

### CHECK ITEMS

- Is there any gas leakage at flare nut connections?
- Has the heat insulation been carried out at flare nut connection?
- Is the connecting cable being fixed to terminal board firmly?
- Is the connecting cable being clamped firmly?
- Is the drainage OK?  
(Refer to "Check the drainage" section)
- Is the earth wire connection properly done?
- Is the indoor unit properly hooked to the installation plate?
- Is the power supply voltage complied with rated value?
- Is there any abnormal sound?
- Is the cooling operation normal?
- Is the thermostat operation normal?
- Is the remote control's LCD operation normal?
- Is the air purifying filter installed?



# 11 Servicing Information

## 11.1. Troubleshooting

### 1. Rated Frequency Operation

During troubleshooting and servicing, rated compressor operating frequency must be obtained in order to check the specification and technical data. Below are the methods used to obtain rated compressor operating specification.

#### (a) Cooling

- (i) Press the Auto button continuously for 5 seconds or less than 8 seconds, the air conditioner starts operation at Cooling rated frequency. ("beep" will be heard at the 5th second.)

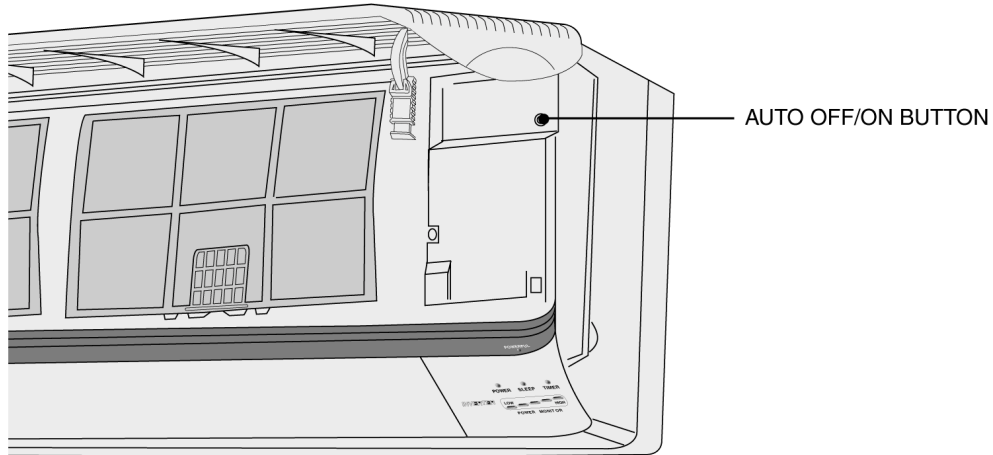

- (ii) Short the service terminal (CN-S) of the outdoor printed circuit board. The air conditioner starts operation at Cooling rated frequency.

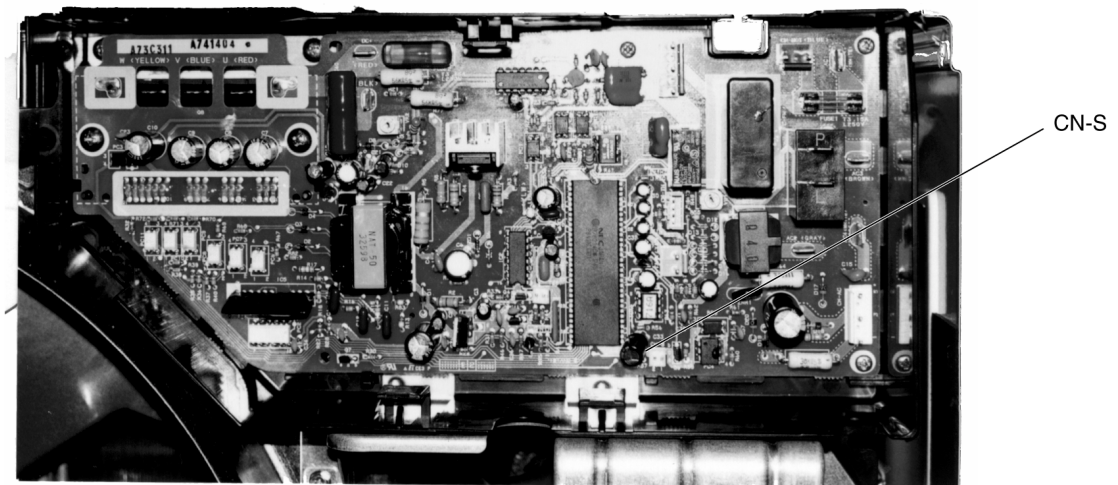

#### (b) Heating

Press the Auto button continuously for 8 seconds or less than 11 seconds, the air conditioner starts operation at Heating rated frequency. ("beep" "beep" will be heard at the 8th second.)

## 2. Troubleshooting Air Conditioner

### Refrigeration cycle system

In order to diagnose malfunctions, make sure that there are no electrical problems before inspecting the refrigeration cycle. Such problems include insufficient insulation, problem with the power source, malfunction of a compressor and a fan.

The normal outlet air temperature and pressure of the refrigeration cycle depends on various conditions, the standard values for them are shown in the table to the right.

Normal Pressure and Outlet Air Temperature (Standard)

	Gas pressure MPa (kg/cm <sup>2</sup> G)	Outlet air temperature (°C)
Cooling Mode	0.4 ~ 0.6 (4 ~ 6)	12 ~ 16
Heating Mode	1.5 ~ 2.1 (15 ~ 21)	36 ~ 45

- ★ Condition:
- Indoor fan speed; High
  - Outdoor temperature 35°C at cooling mode and 7°C at heating mode.
  - Compressor operates at rated frequency

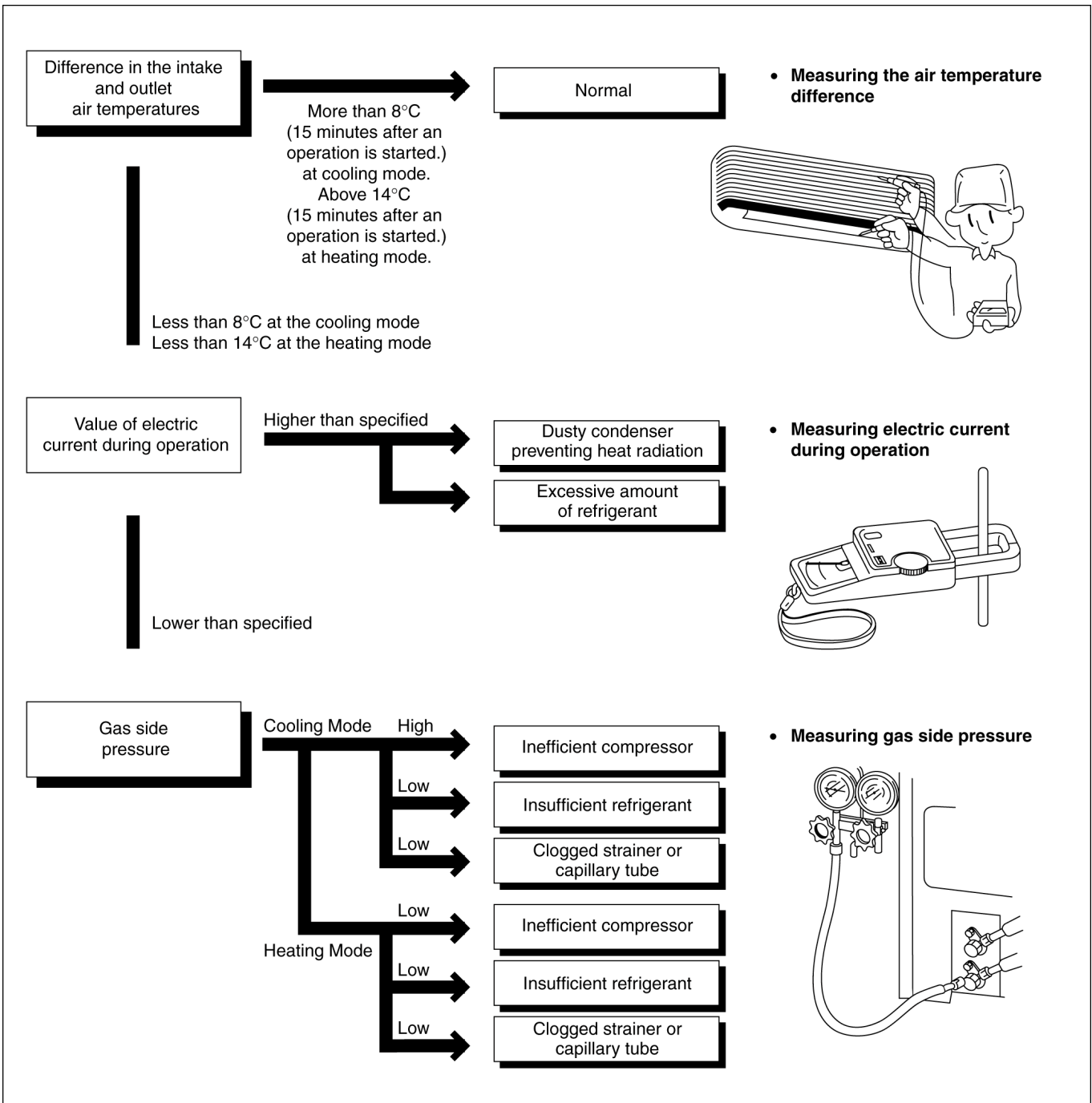

### 1. Relationship between the condition of the air conditioner and pressure and electric current

Condition of the air conditioner	Cooling Mode			Heating Mode		
	Low Pressure	High Pressure	Electric current during operation	Low Pressure	High Pressure	Electric current during operation
Insufficient refrigerant (gas leakage)	↘	↘	↘	↘	↘	↘
Clogged capillary tube or Strainer	↘	↘	↘	↗	↗	↗
Short circuit in the indoor unit	↘	↘	↘	↗	↗	↗
Heat radiation deficiency of the outdoor unit	↗	↗	↗	↘	↘	↘
Inefficient compression	↗	↘	↘	↗	↘	↘

- Carry on the measurements of pressure, electric current, and temperature fifteen minutes after an operation is started.

## 11.2. Self Diagnosis Display

The diagnostic display can be seen on the receiver of the Front Grille.

- When an abnormality occurs, the unit automatically stops, and the TIMER LED blinks to indicate a malfunction. At the same time, the type of abnormality will be indicated on the receiver as shown in the diagram below. Providing this information reduces the time spent in diagnosing procedures.

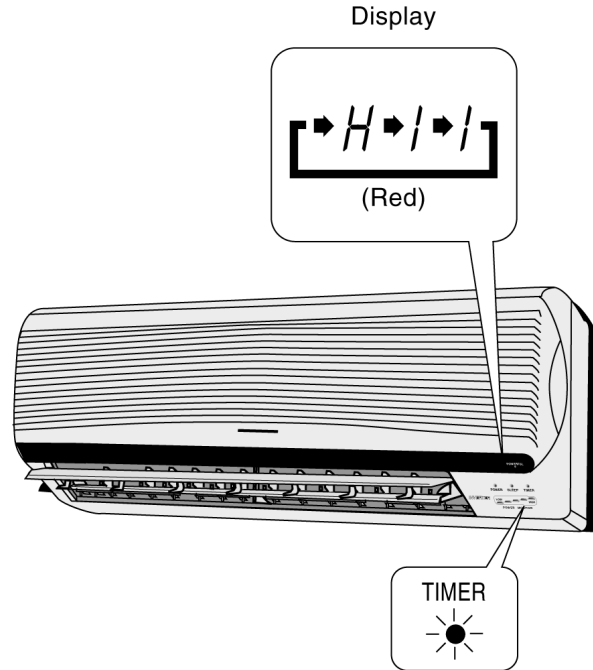

- The diagnostic display disappears when the power is turned off.
- When power is re-supplied and the Diagnostic Terminals the Remote Control is shorted, the type of the previous abnormality and the protection control works will be displayed and repeated on the receiver for 4 times.

### Diagnostic Terminals

To be used by the service technician only.

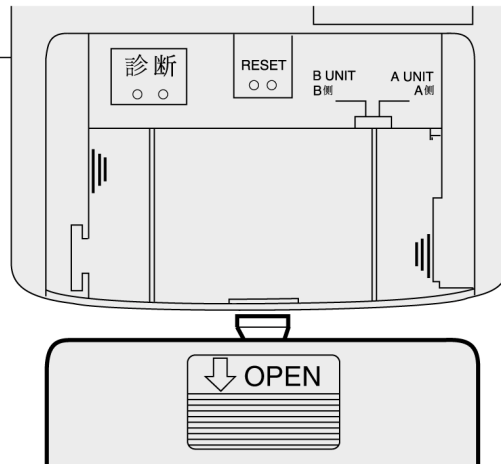

- By starting forced cooling operation using AUTO button (press AUTO button for 5 seconds or < 8 seconds) and short the Diagnostic Terminals at the remote control, the previous abnormalities are deleted.
- Depending on the type of abnormality, you may be able to override the abnormality and use a temporary operation (for abnormalities indicated by O mark in the table).

Use the remote control to select cooling or heating operation mode and press OFF/ON button. At this moment, four short beeps; "beep. beep. beep. beep" will sound and TIMER LED will blink.

Diagnosis display	Abnormality / Protection control	Abnormality Judgement	Temporary operation	Primary location to verify
H11	Indoor / outdoor abnormal communication	1 min after starting operation	-	<ul style="list-style-type: none"> <li>Internal / external cable connections</li> <li>Indoor / Outdoor PCB</li> </ul>
H14	Indoor intake air temperature sensor abnormality		-	<ul style="list-style-type: none"> <li>Intake air temperature sensor (defective or disconnected) ✕ 1</li> </ul>
H15	Outdoor compressor temperature sensor abnormality		-	<ul style="list-style-type: none"> <li>Compressor temperature sensor (defective or disconnected)</li> </ul>
H16	Outdoor Current Transformer open circuit		-	<ul style="list-style-type: none"> <li>Outdoor PCB</li> <li>IPM (Power transistor) module</li> </ul>
H19	Indoor fan motor mechanism lock		-	<ul style="list-style-type: none"> <li>Indoor PCB</li> <li>Fan motor</li> </ul>
H23	Indoor heat exchanger temperature sensor abnormality		O (Cooling only)	<ul style="list-style-type: none"> <li>Heat exchanger temperature sensor (defective or disconnected)</li> </ul>
H27	Outdoor air temperature sensor abnormality		O	<ul style="list-style-type: none"> <li>Outdoor temperature sensor (defective or disconnected)</li> </ul>
H28	Outdoor heat exchanger temperature sensor abnormality		O	<ul style="list-style-type: none"> <li>Outdoor heat exchanger temperature sensor (defective or disconnected)</li> </ul>
H98	Indoor high pressure protection		-	<ul style="list-style-type: none"> <li>Air filter dirty</li> <li>Air circulation short circuit</li> </ul>
H99	Indoor heat exchanger anti-freezing protection		-	<ul style="list-style-type: none"> <li>Insufficient refrigerant</li> <li>Air filter dirty</li> </ul>
F11	Cooling / Heating cycle changeover abnormality	4 times occurrence within 40 minutes	-	<ul style="list-style-type: none"> <li>4-way valve</li> <li>V-coil</li> </ul>
F91	Refrigeration cycle abnormality	2 times occurrence within 30 minutes	-	<ul style="list-style-type: none"> <li>No refrigerant (3-way valve is closed)</li> </ul>
F93	Outdoor compressor abnormal revolution	4 times occurrence within 30 minutes	-	<ul style="list-style-type: none"> <li>Compressor</li> <li>Outdoor PCB</li> </ul>
F96	IPM (power transistor) overheating protection	4 times occurrence within 40 minutes	-	<ul style="list-style-type: none"> <li>Excess refrigerant</li> <li>Improper heat radiation</li> <li>IPM (Power transistor)</li> </ul>
F97	Outdoor compressor overheating protection	4 times occurrence within 20 minutes	-	<ul style="list-style-type: none"> <li>Insufficient refrigerant</li> <li>Compressor</li> </ul>
F98	Total running current protection	3 times occurrence within 30 minutes	-	<ul style="list-style-type: none"> <li>Excess refrigerant</li> <li>Improper heat radiation</li> </ul>
F99	Outdoor Direct Current (DC) peak detection	7 times occurrence continuously	-	<ul style="list-style-type: none"> <li>Outdoor PCB</li> <li>IPM (Power transistor)</li> <li>Compressor</li> </ul>

✕ 1

This diagnosis mode can be omitted by the following procedure.

- Press the AUTO button (at indoor unit) continuously for 16 seconds or < 21 seconds, "beep", "beep", "beep", "beep" will be heard at 16th second. "E1" will be displayed at the indoor unit. This is to indicate H14 abnormality detection is enable.
- Press the Auto switch once. A "beep" sound will be heard. "E2" will be displayed at the indoor unit. This is to indicate H14 abnormality detection is disabled.

(a) Current Transformer Defective

When the Current Transformer (CT) is an open circuit, total running current is less than 1.88A and the indicated frequency is 53 Hz (CU-G95KE) or 74 Hz (CU-G125KE) or above. If this condition continues for 20 seconds, the abnormality signal is sent from outdoor to indoor after 3 minutes of operation and [H16] is displayed.

(b) 4 Way Valve Defective

(i) Heating Operation (except Deice)

When the indoor heat exchanger temperature is lower than 5°C after 4 minutes of operation, the operation stops and restarts after 3 minutes. If this phenomenon occurs for 4 times within 40 minutes, [F11] is displayed.

(ii) Cooling Operation

When the indoor heat exchanger temperature is higher than 45°C after 4 minutes of operation, the operation stops and restarts after 3 minutes. If this phenomenon occurs for 4 times within 40 minutes, [F11] is displayed.

The abnormality is not judged in the following conditions:

- deice operation
- 2 minutes after deice operation
- hot start
- 2 minutes after hot start
- 3 minutes after heating and cooling/soft dry mode changeover

## 11.3. Remote Control

### a. Remote Control Reset

When the batteries are inserted for the first time, or the batteries are replaced, all the indications will blink and the remote control might not work.

If this happens, remove the back cover of the remote control and you will find a resetting terminal, and by shorting it with a minus screwdriver, it will return to normal.

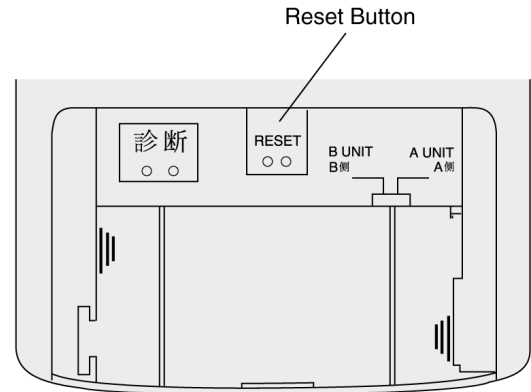

### b. Changing the wireless remote control transmission code

When two indoor units are installed in the same room, in order to prevent operating errors caused by using two remote controls, set up the remote control [B ↔ A] switch. The unit is set to A when it is shipped.

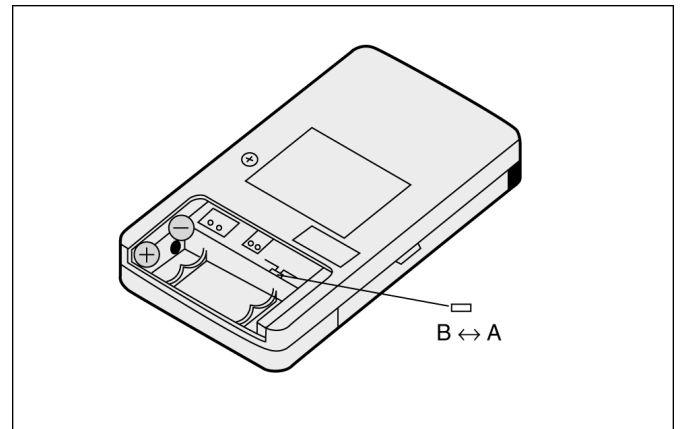

By adding a jumper wire to the remote control side, it is possible to select 4 transmission codes including one at time of delivery condition (1).

	Remote Control		Indoor unit	Note
	Switch SW B ↔ A	J - B	Segment Display	
1	A	—	A	At product delivery
2	B	—	B	
3	A	Jumper wire	C	
4	B	Jumper wire	D	

#### Procedure:-

- Press the Auto button (at indoor unit) continuously for 11 seconds or < 16 seconds; “beep” “beep” “beep” will be heard and the current transmission code is displayed (A or b or c or d). To switch to condition (2) transmission code as above, switch over the Remote Control A ↔ B switch to B; and press any button at the remote control to set the transmission code.
- To switch to condition (3) and (4) transmission code, follow the same procedure as mentioned above.

## 11.4. Disassembly of Parts

### a. Indoor Control Board Removal Procedure

#### 1. Remove the Front Grille

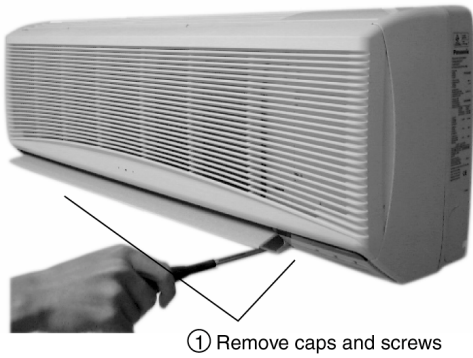

Fig. 1

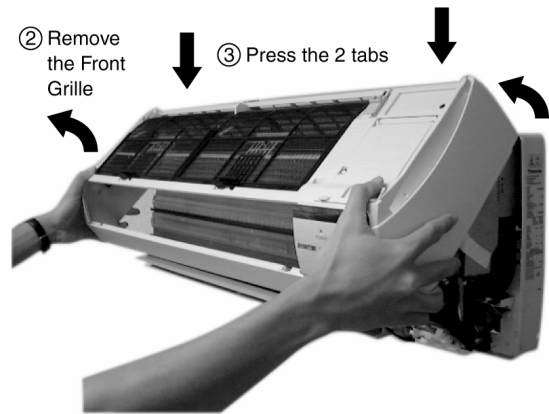

Fig. 2

#### 2. Remove the Indoor Control Board

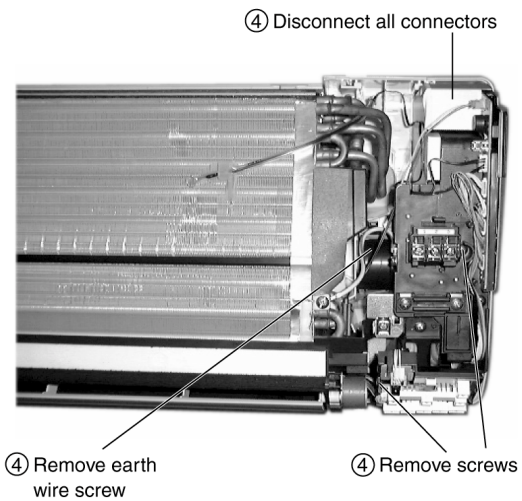

Fig. 3

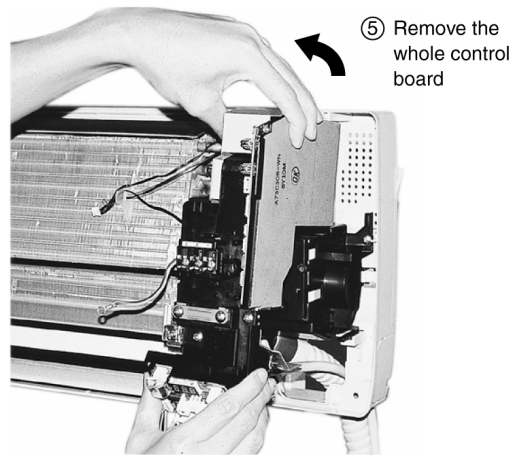

Fig. 4

Note: Remove the indoor and outdoor connecting wires from terminal **1**, **2**, **3** and **⊕**.



### a. Removal of Electronic Controller Procedure

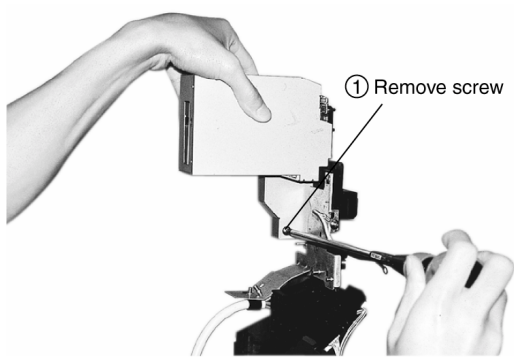

Fig. 5

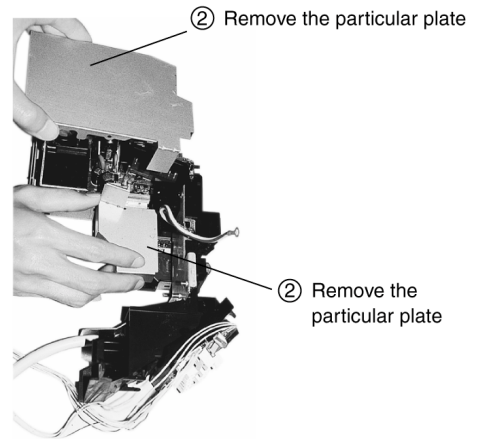

Fig. 6

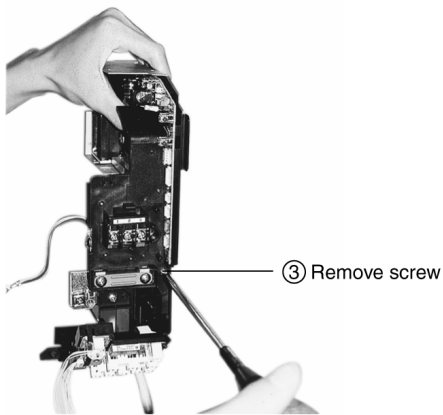

Fig. 7

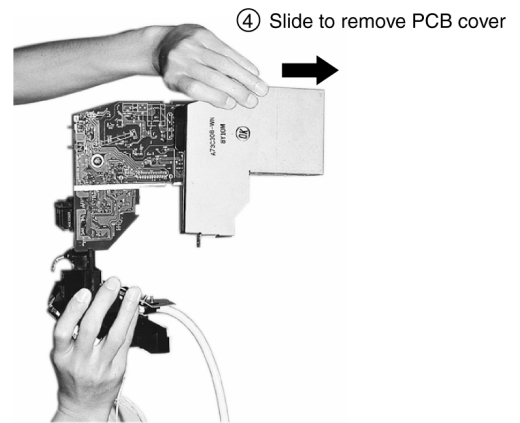

Fig. 8

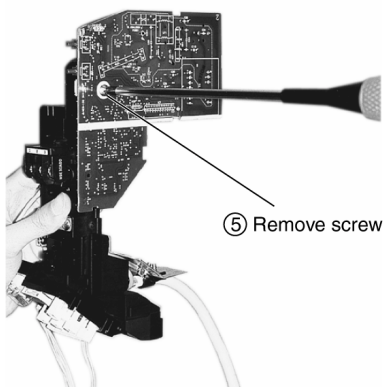

Fig. 9

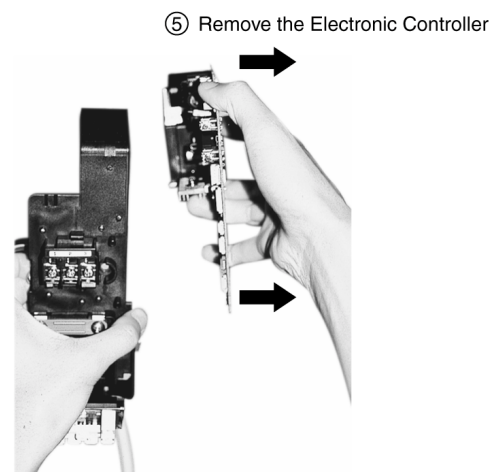

Fig. 10

### c. Indoor Fan Motor Removal Procedure

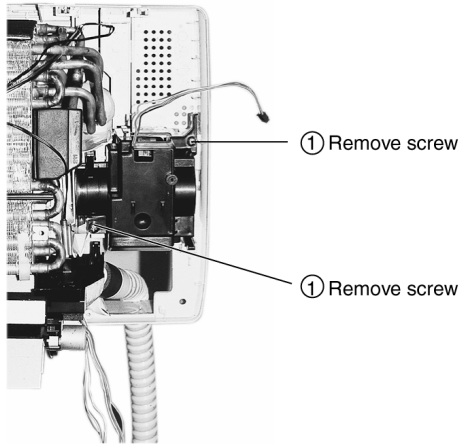

Fig. 11

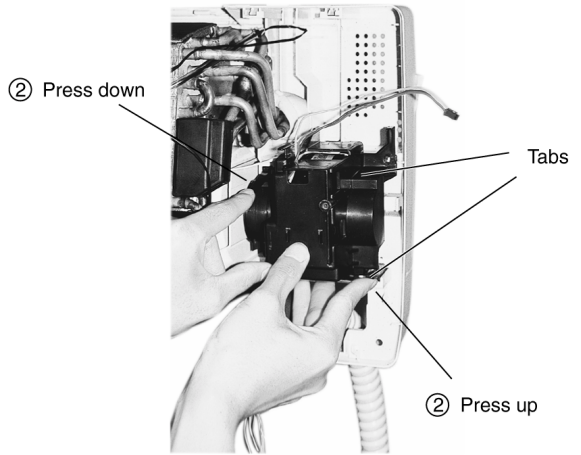

Fig. 12

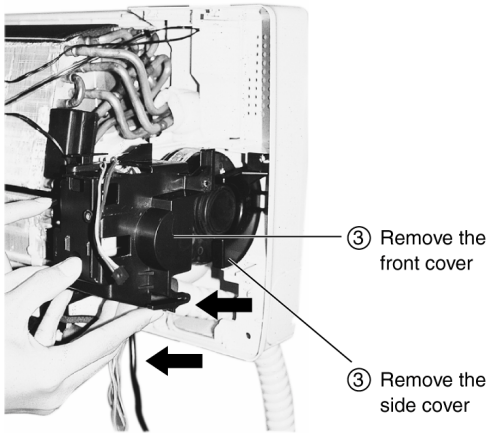

Fig. 13

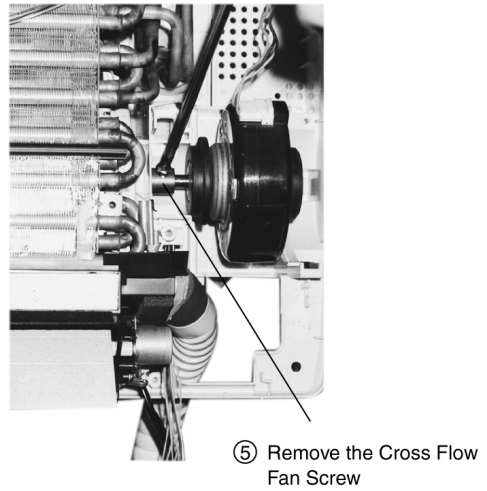

Fig. 14

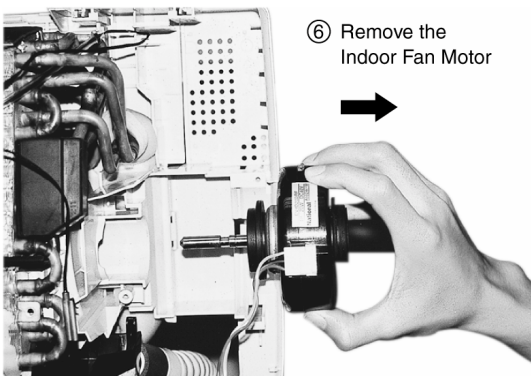
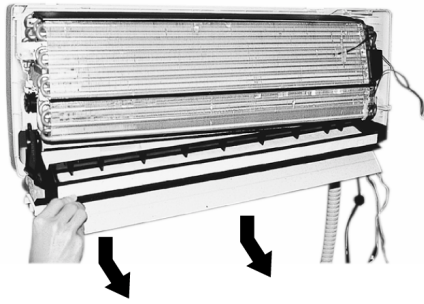

Fig. 15

### d. Cross Flow Fan Removal Procedure

#### 1. Remove Discharge Grille



① Remove the Discharge Grille

Fig. 16

#### 1. Remove Cross Flow Fan

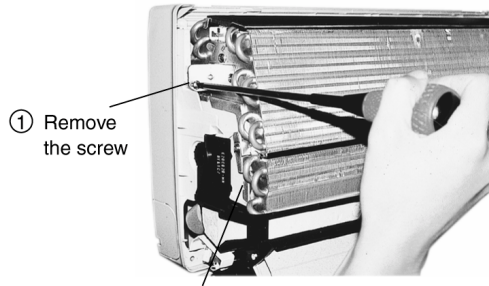

① Remove the screw

② Release the slot of indoor heat exchanger from the chassis

Fig. 17

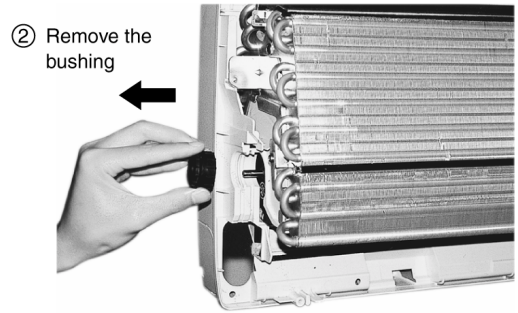

② Remove the bushing

Fig. 18

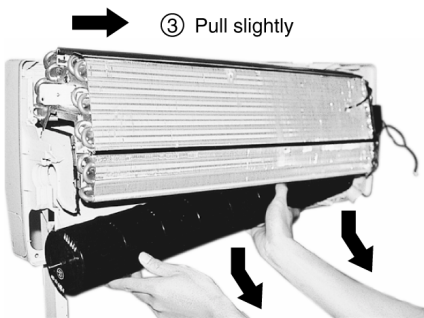

③ Pull slightly

④ Remove the Cross Flow Fan

Fig. 19

**d. Outdoor Electronic Controller Removal Procedure**

**⚠ WARNING**

- Be save to return the wiring to its original position
- There are many high voltage components within the heat sink cover so never touch the interior during operation. Wait at least two minutes after power has been turned off.

**1. Remove the top pane and front panel**

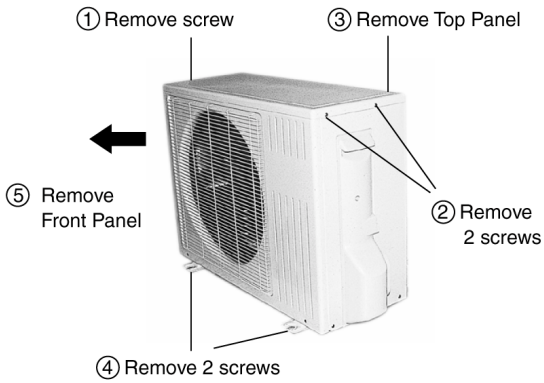

Fig. 20

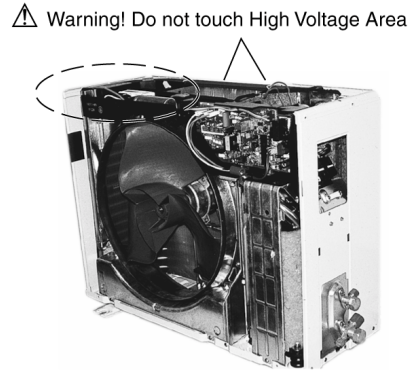

Fig. 21

**2. Remove the Outdoor Electronic Controller**

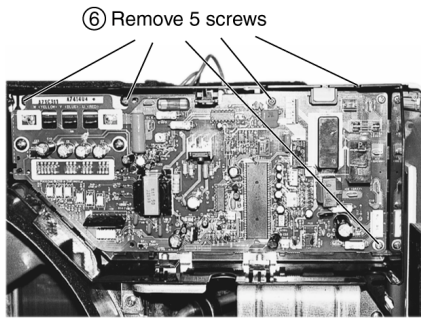

Fig. 22

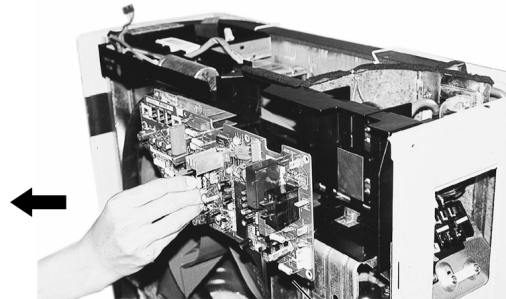
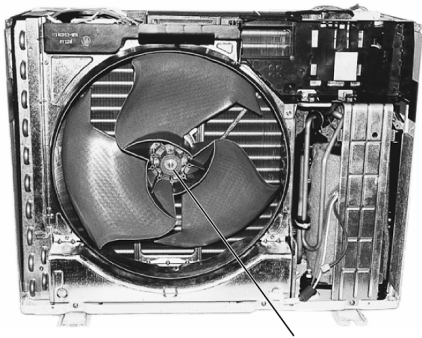

Fig. 23

⚠ Caution! When handling electronic controller, be careful of electrostatic discharge.

Note: Use magnetic type of screw driver to avoid dropping of the screws.

**f. Propeller Fan Removal Procedure**



① Remove the nut (clockwise direction)

Fig. 24

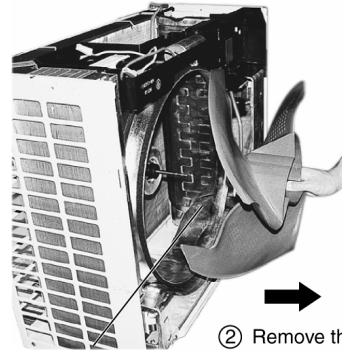

② Remove the propeller fan

Fig. 25

**f. Outdoor Fan Motor Removal Procedure**

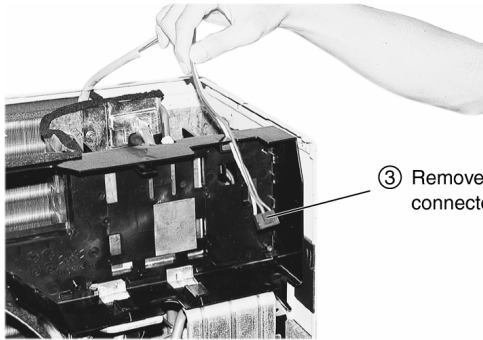

③ Remove the connector

Fig. 26

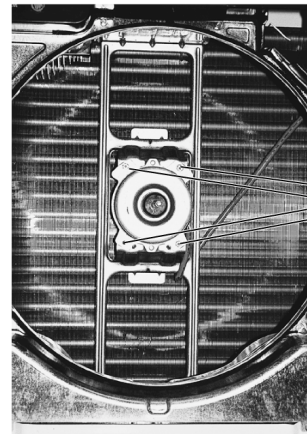

④ Remove 4 screws

Fig. 27

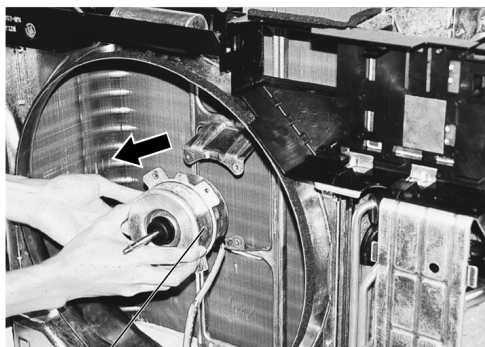

⑤ Remove the Outdoor Fan Motor

Fig. 26

# 12 Technical Data

## ■ Operation characteristics

### CS-G95KE / CU-G95KE

#### ● Cooling Characteristic

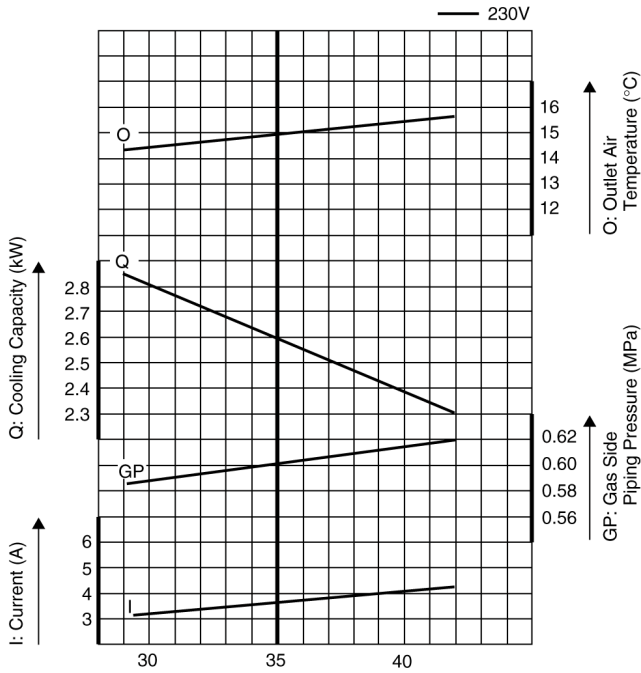

OUTDOOR AIR TEMPERATURE (°C)  
 [Condition] Room temperature: 27/19°C  
 Cooling Operation: at High Fan  
 Piping length: 5m  
 Rated Frequency Operation

#### ● Piping Length Characteristic (Cooling)

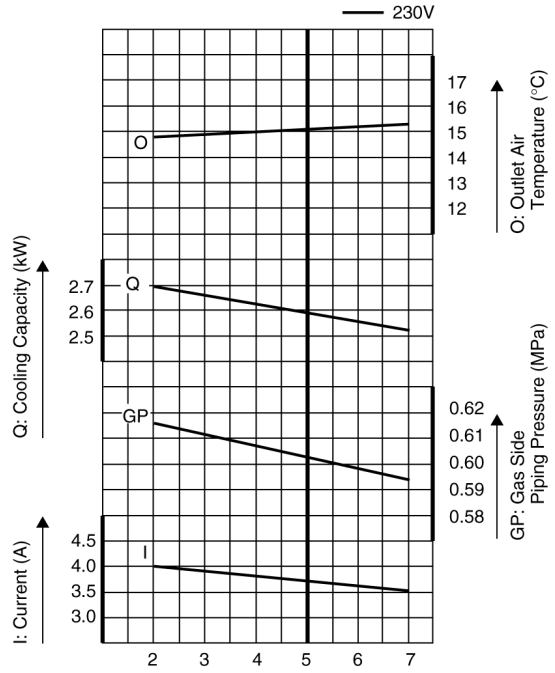

PIPING LENGTH (m)  
 [Condition] Room temperature: 27/19°C  
 Cooling Operation: at High Fan  
 Piping length: 5m  
 Rated Frequency Operation

#### ● Heating Characteristic

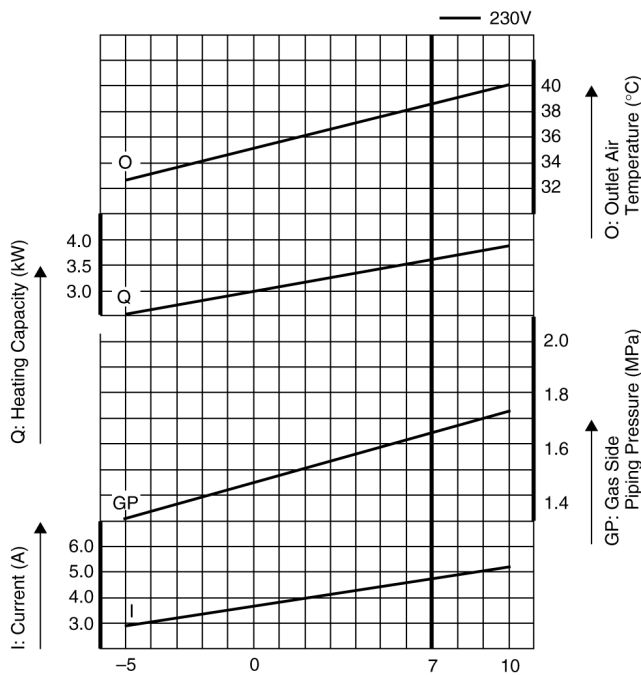

OUTDOOR AIR TEMPERATURE (°C)  
 [Condition] Room temperature: 20°C  
 Heating Operation: at High Fan  
 Piping length: 5m  
 Rated Frequency Operation

#### ● Piping Length Characteristic (Heating)

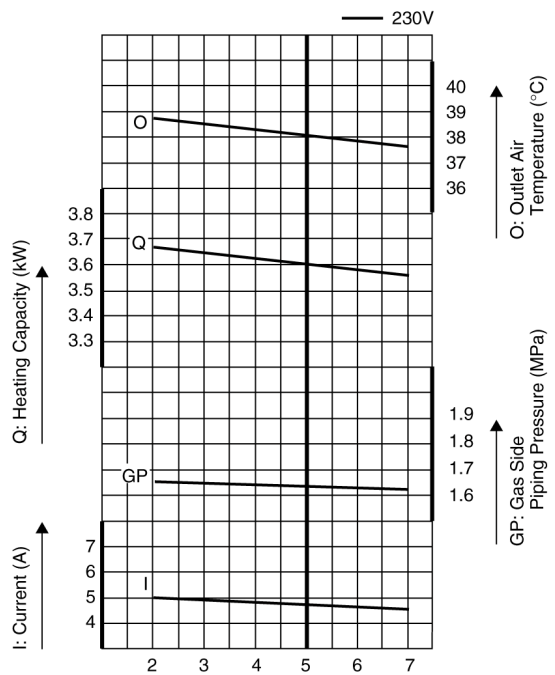

PIPING LENGTH (m)  
 [Condition] Room temperature: 20°C  
 Heating Operation: 7/6°C  
 Piping length: at High Fan  
 Rated Frequency Operation

## ■ Operation characteristics

### CS-G125KE / CU-G125KE

#### ● Cooling Characteristic

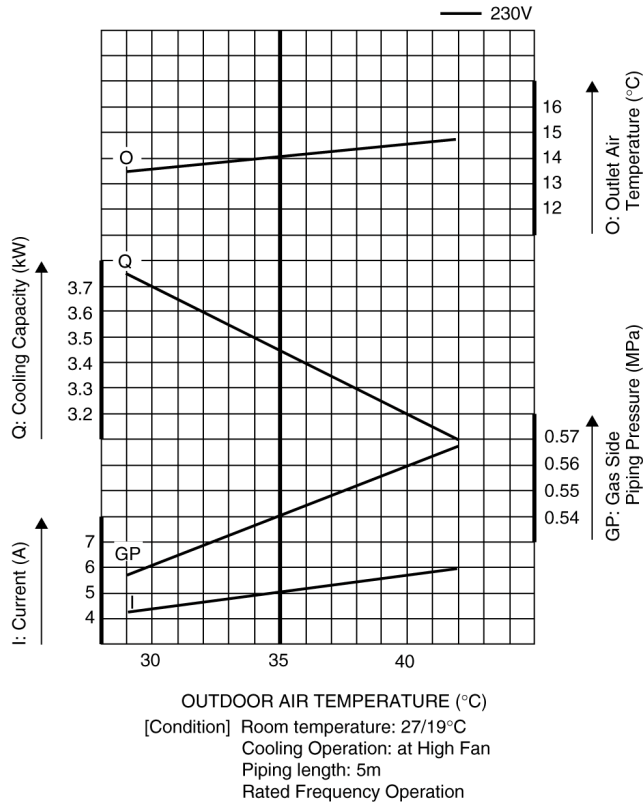

#### ● Piping Length Characteristic (Cooling)

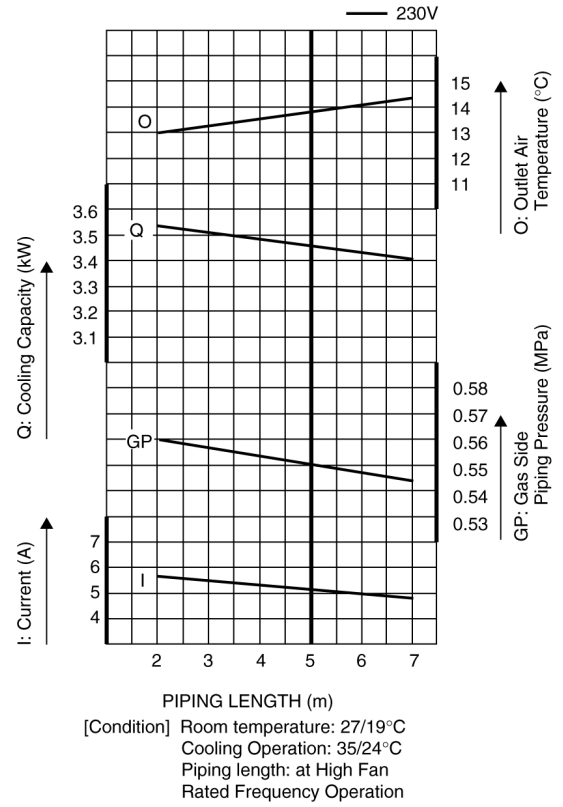

#### ● Heating Characteristic

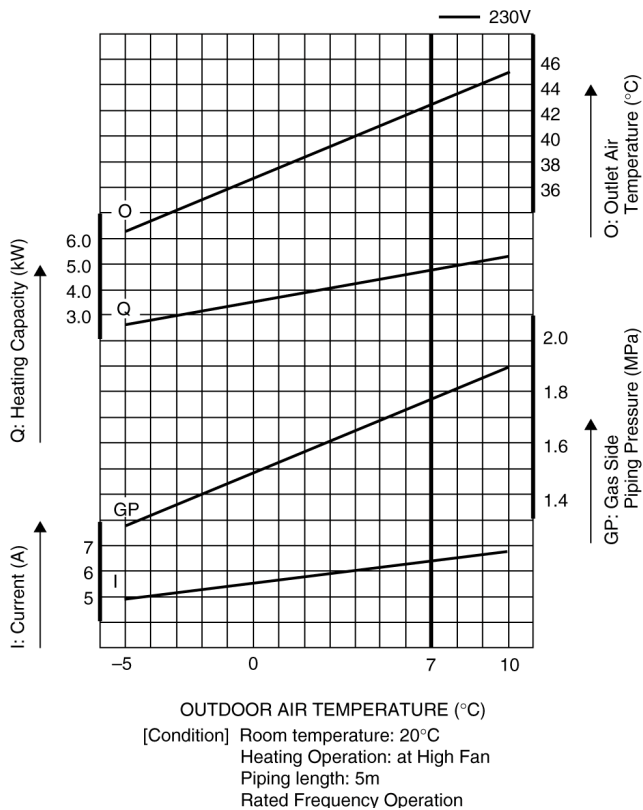

#### ● Piping Length Characteristic (Heating)

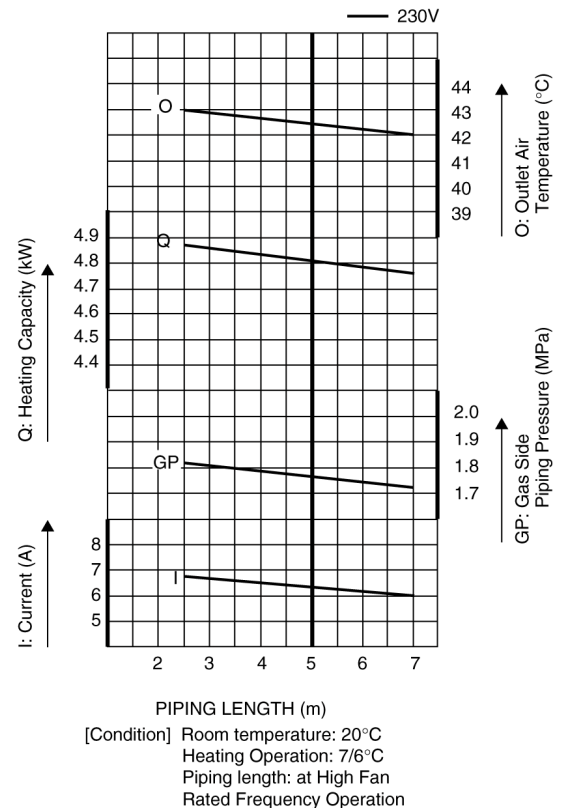

## ■ Sensible Capacity Chart

### • CS-G95KE

230V Indoor wet bulb temp.	Outdoor Temp. (°C)											
	30			35			40			46		
	TC	SHC	IP	TC	SHC	IP	TC	SHC	IP	TC	SHC	IP
17.0°C	2.58	1.96	0.67	2.41	1.88	0.72	2.24	1.80	0.77	2.04	1.71	0.83
19.0°C				2.60		0.73						
19.5°C	2.83	2.05	0.68	2.65	1.97	0.73	2.46	1.89	0.78	2.24	1.80	0.85
22.0°C	3.09	2.12	0.69	2.88	2.04	0.75	2.68	1.97	0.80	2.44	1.88	0.86

### • CS-G125KE

230V Indoor wet bulb temp.	Outdoor Temp. (°C)											
	30			35			40			46		
	TC	SHC	IP	TC	SHC	IP	TC	SHC	IP	TC	SHC	IP
17.0°C	3.42	2.59	0.96	3.20	2.49	1.03	2.97	2.39	1.11	2.70	2.27	1.19
19.0°C				3.45		1.05						
19.5°C	3.76	2.72	0.98	3.51	2.61	1.05	3.27	2.51	1.13	2.97	2.39	1.22
22.0°C	4.10	2.82	1.00	3.83	2.71	1.07	3.56	2.61	1.15	3.24	2.49	1.24



# 13 Exploded View

## CS-G95KE / CS-G125KE

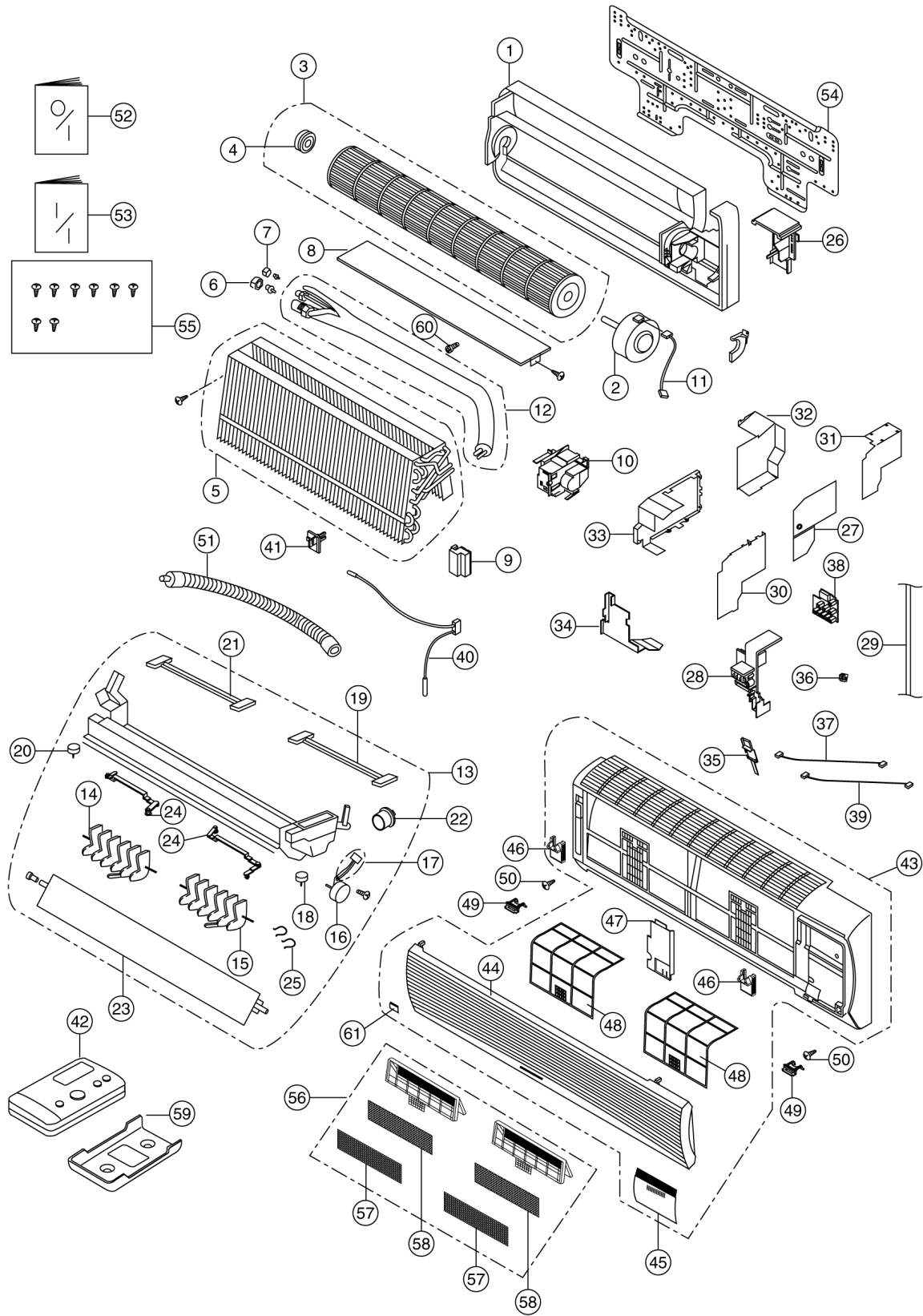

**Note:**

The above exploded view is for the purpose of parts disassembly and replacement.  
 The non-numbered parts are not kept as standard service parts.

# 14 Replacement Parts List

<Model: CS-G95KE / CS-G125KE>

NO.	DESCRIPTION & NAME	Q'TY	CS-G95KE	CS-G125KE	REMARKS
1	CHASSY COMPLETE	1	CWD50C338	←	
2	FAN MOTOR	1	CWA98244	←	0
3	CROSS FLOW FAN	1	CWH02C060	←	
4	BEARING	1	CWH64K007	←	
5	EVAPORATOR	1	CWB30C271	←	
6	FLARE NUT (1/2") OR (3/8")	1	CWT25005 (3/8")	CWT25007 (1/2")	
7	FLARE NUT (1/4")	1	CWH6002140	←	
8	SPACER COMPLETE	1	CWH54C031	←	
9	ANTI VIBRATION BUSHING	1	CWH50211	←	
10	FAN MOTOR COVER	1	CWD931039	←	
11	LEAD WIRE - FAN MOTOR	1	CWA67C2310	←	
12	TUBE ASSY	1	CWT01C2136	CWT01C623	
13	DISCHARGE GRILLE COMPLETE	1	CWE20C2063	←	
14	VANE COMPLETE (LEFT)	1	CWE24C113	←	
15	VANE COMPLETE (RIGHT)	1	CWE24C114	←	
16	MOTOR - AIR SWING (UP/DOWN)	1	CWA98C033	←	0
17	LEAD WIRE - AIR SWING MOTOR (UP/DOWN)	1	CWA67C1814	←	
18	MOTOR - AIR SWING (RIGHT)	1	CWA98276	←	0
19	LEAD WIRE - AIR SWING MOTOR (RIGHT)	1	CWA67C2187	←	
20	MOTOR - AIR SWING (LEFT)	1	CWA98277	←	0
21	LEAD WIRE - AIR SWING MOTOR (LEFT)	1	CWA67C2188	←	
22	CAP COMPLETE	1	CWH52C003	←	
23	VANE	1	CWE241027A	←	
24	LEVER COMPLETE	2	CWH65C026	←	
25	RETAINING RING	2	XUC3	←	
26	PARTICULAR PIECE	1	CWD931019	←	
27	ELECTRONIC CONTROLLER	1	CWA742329	CWA742328	0
28	TERMINAL BOARD COMPLETE	1	CWA28C2038	←	0
29	POWER SUPPLY CORD	1	CWA20C763	CWA20C764	
30	CONTROL BOARD COVER	1	CWH13463	←	
31	CONTROL BOARD COVER	1	CWH13465	←	
32	CONTROL BOARD COVER	1	CWH13466	←	
33	CONTROL BOARD COVER	1	CWH13464	←	
34	PARTICULAR PIECE	1	CWD931040	←	
35	INDICATOR HOLDER	1	CWD931018	←	
36	ELECTRONIC CONTROLLER (RECEIVER)	1	CWA74919	←	0
37	LEAD WIRE - RECEIVER	1	CWA67C2913	←	
38	INDICATOR COMPLETE	1	CWE39C1023	←	0
39	LEAD WIRE - INDICATOR	1	CWA67C3477	←	
40	SENSOR COMPLETE	1	CWA50C613	←	0
41	HOLDER SENSOR	1	CWH32142	←	
42	REMOTE CONTROL SWITCH	1	CWA75C2083	←	
43	FRONT GRILLE COMPLETE	1	CWE11C2110	←	
44	INTAKE GRILLE COMPLETE	1	CWE22C1006	←	
45	DECORATION BASE	1	CWE35C1008	←	
46	TAB	2	CWD931020	←	
47	GRILLE DOOR COMPLETE	1	CWE141014	←	
48	AIR FILTER	2	CWD00240	←	
49	CAP - FRONT GRILLE	2	CWH52267	←	
50	SCREW - FRONT GRILLE	2	XTN4+16C	←	
51	DRAIN HOSE	1	CWH5880580	←	
52	OPERATING INSTRUCTIONS	1	CWF563167	←	
53	INSTALLATION INSTRUCTIONS	1	CWF612099	←	
54	INSTALLATION PLATE	1	CWH36157	←	
55	BAG COMPLETE (INSTALLATION SCREW)	1	CWH82C067	←	
56	AIR PURIFYING FILTER COMPLETE	1	CWD00C1028	←	
57	AIR PURIFYING FILTER (CATECHIN)	2	CWD001014	←	0
58	AIR PURIFYING FILTER (DEODORIZING)	2	CWD001033	←	0
59	REMOTE CONTROL HOLDER	1	CWH36161	←	
60	SCREW - CROSS FLOW FAN	1	CWH4580304	←	
61	DECORATION BASE	1	CWE35K1052	←	

(Note)

- All parts are supplied from MACC, Malaysia (Vendor Code: 086).
- "O" marked parts are recommended to be kept in stock.

# 15 Exploded View

CU-G95KE / CU-G125KE

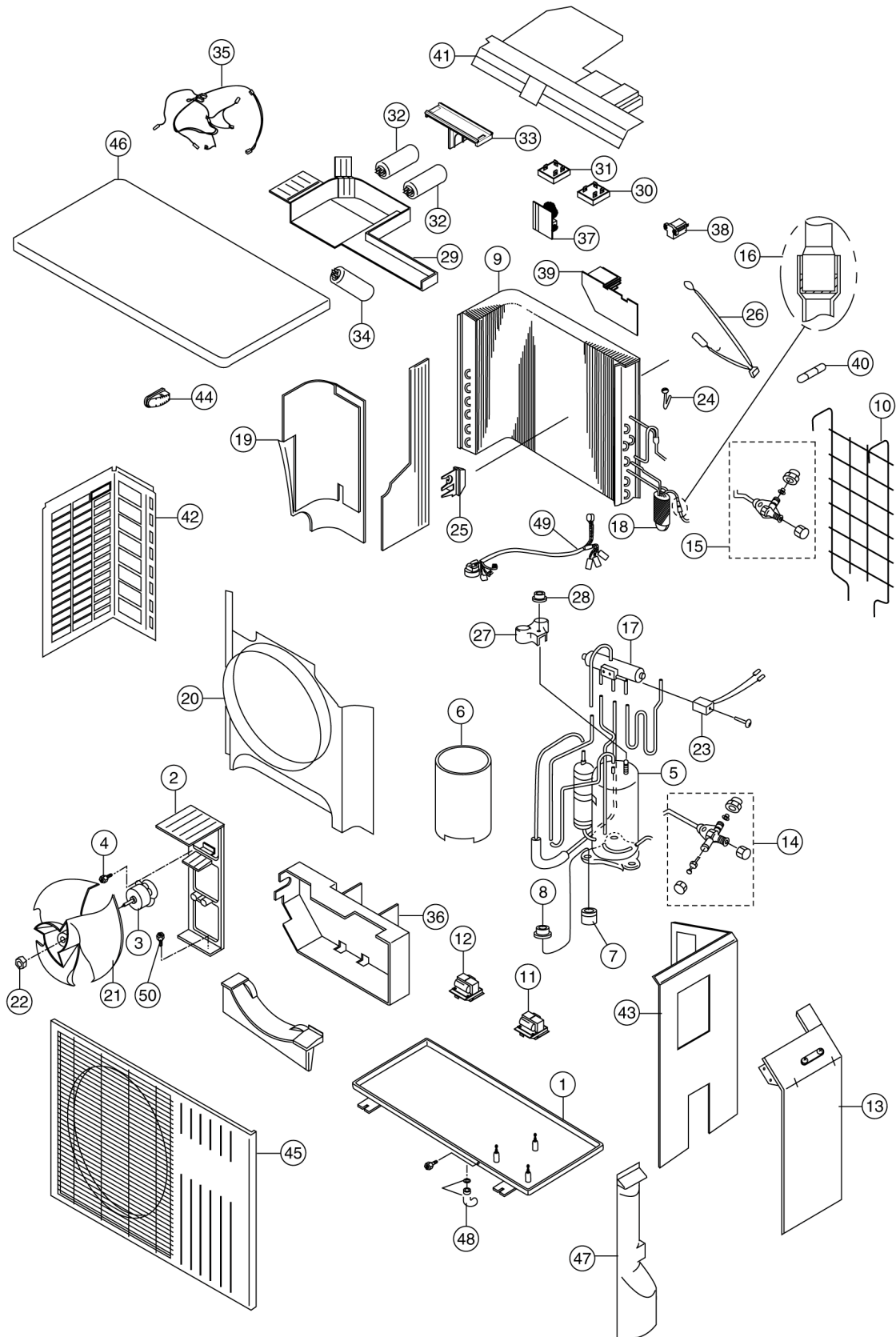

**Note:**

The above exploded view is for the purpose of parts disassembly and replacement.  
The non-numbered parts are not kept as standard service parts.

# 16 Replacement Parts List

<Model: CU-G95KE / CU-G125KE>

NO.	DESCRIPTION & NAME	Q'TY	CU-G95KE	CU-G125KE	REMARKS
1	CHASSY COMPLETE	1	CWD50K660A	←	
2	FAN MOTOR BRACKET	1	CWD54254	CWD54255	
3	FAN MOTOR	1	CWA95384	CWA95380	0
4	SCREW - FAN MOTOR	4	CWH55406	←	
5	COMPRESSOR	1	2RD132X5BB03	2RD132X5BA03	0
6	SOUND PROOF MATERIAL	1	CWG302029	←	
7	ANTI - VIBRATION BUSHING	3	CWH50183	←	
8	NUT	3	CWH56000	←	
9	CONDENSER	1	CWB32C350	CWB32C349	
10	WIRE NET	1	CWD04197A	CWD04198A	
11	REACTOR (RIGHT)	1	CWA421010	←	
12	REACTOR (LEFT)	1	CWA421011	←	
13	HOLDER COUPLING	1	CWH35177	←	
14	3 WAY VALVE	1	CWB01481	CWB01480	
15	2 WAY VALVE	1	CWB02308	←	
16	STRAINER	1	CWB11025	←	
17	4 WAY VALVE	1	CWB00002	CWB00003	
18	TUBE ASSY (CAPILLARY TUBE)	1	CWT01C668	CWT01C667	
19	SOUND PROOF BOARD	1	CWH15290	CWH15291	
20	AIR GUIDER PROPELLER FAN	1	CWD31C035	←	
21	PROPELLER FAN	1	CWH00K087	←	
22	NUT	1	CWH56053	←	
23	V COIL COMPLETE	1	CWA43C2007	←	0
24	HOLDER SENSOR	1	CWH32074	←	
25	HOLDER SENSOR	1	CWH32082	←	
26	SENSOR COMPLETE	1	CWA50C614	←	0
27	TERMINAL COVER	1	CWH171001	←	
28	NUT	1	CWH7080300	←	
29	CONTROL BOARD	1	CWH10978	←	
30	DIODE BRIDGE 1	1	A54S25VB60	←	0
31	DIODE BRIDGE 2	1	A54D15VBA80	A54D25VB80	0
32	CAPACITOR	1/2	CWA30201 (1)	CWA30200 (2)	0
33	HOLDER CAPACITOR	1	CWH30183	CWH30184	
34	SH CAPACITOR	1	CWA31137	←	0
35	LEAD WIRE COMPLETE (ZNR)	1	CWA67C3041	CWA67C3042	
36	CONTROL BOARD	1	CWH10979	←	
37	NOISE FILTER	1	CWA49C209	←	0
38	RESISTOR	1	CWA47038	←	0
39	ELECTRONIC CONTROLLER	1	CWA742343	CWA742342	0
40	FUSE	1	XBACW12	←	0
41	CONTROL BOARD COVER	1	CWH13C324	←	
42	CABINET SIDE PLATE	1	CWE04218A	←	
43	CABINET SIDE PLATE	1	CWE04217A	CWE04219A	
44	HANDLE	1	CWE16037C	←	
45	CABINET FRONT PLATE	1	CWE06K104A	←	
46	CABINET TOP PLATE	1	CWE03K036A	CWE03K037A	
47	CONTROL BOARD COVER	1	CWH13C325	←	
48	DRAIN ELBOW	1	CWH5850080	←	
49	SENSOR COMPLETE - COMPRESSOR	1	CWA67C3563	←	
50	SCREW - FAN MOTOR BRACKET	2	CWH55189	←	

(Note)

- All parts are supplied from MACC, Malaysia (Vendor Code: 086).
- "O" marked parts are recommended to be kept in stock.

# 17 Electronic Parts List

<Model : CWA742328 / CWA742329>

SYMBOL	DESCRIPTION & NAME	PART NO.
BZ1	BUZZER	A48040
D1, D2, D4, D5, D7, D8	DIODE	A541SS355T
D3, D6, D9	DIODE	A54D1F60
DB1	DIODE BRIDGE	A54D3SBA60F1
FUSE1	FUSE	XBACW067
IC1	INTEGRATED CIRCUIT	A5278366F114
IC2	INTEGRATED CIRCUIT	A52BR9020F
IC3	INTEGRATED CIRCUIT	A52MPC393G22
IC4	INTEGRATED CIRCUIT	A52PST600DR
IC5, IC6	INTEGRATED CIRCUIT	A52A2003GR2
IC7 & IC8	INTEGRATED CIRCUIT	A52C108
ICX	INTEGRATED CIRCUIT	A532122A (CWA742328) A532123A (CWA742329)
PC1	PHOTO COUPLER	A52S2501L1KC
PC2	PHOTO COUPLER	A52TLP371LF
PC3	PHOTO COUPLER	A52LP521L1BL
Q1, Q3	TRANSISTOR	A55DC143XKTX
Q4, Q10	TRANSISTOR	A55DA143XKTX
SW4	SWITCH	A01059
T1	TRANSFORMER	A40C295
ZNR1	ZNR	ERZVEAV511
ZNR2	ZNR	ERZVAV271
X1	ZENAR DIODE	A45CTS4MG02T
FUSE HOLDER	FUSE HOLDER	XCSCW032

## &lt;Model : CWA742343 / CWA742342&gt;

SYMBOL	DESCRIPTION & NAME	PART NO.
C-FM	CAPACITOR - FM	A31735
CT1	CURRENT TRANSFORMER	A40260
D1	DIODE	A54AU02ZV0
D17, D18, D20	DIODE	A54RA15-06V3
D19	DIODE	A54RA15-10V3
D2, D3, D4, D5, D8	DIODE	A54RA22-04V3
D6	DIODE	A541SS136T
D9 ~ D16	DIODE	A54MA165TA5
FUSE1, FUSE2	FUSE	XBACW067
IC1	INTEGRATED CIRCUIT	A5278214WP43
IC2	INTEGRATED CIRCUIT	A52MPA2003C
IC3	INTEGRATED CIRCUIT	A52C050
IC4	INTEGRATED CIRCUIT	A52M51951AST
IC5	INTEGRATED CIRCUIT	A52BX8454
IC6	INTEGRATED CIRCUIT	A52AN78L10TA
IC7	INTEGRATED CIRCUIT	A52AN79L10TA
IC8	INTEGRATED CIRCUIT	A52MPC339C
ICX	SERIAL PROM	A53716B (CWA742342) A53717B (CWA742343)
LED1	LED	A54SLR342DB7
PC1, PC3, PC12, PC13	PHOTO COUPLER	A52S2501-1PC
PC2	PHOTO COUPLER	A52LP521-3GB
PC4	PHOTO COUPLER	A52PS2633E
PC5	PHOTO COUPLER	A52S2501-1LC
PC6 ~ PC11	PHOTO COUPLER	A52LP521-1GH
Q1	TRANSISTOR	A55C070
Q4	TRANSISTOR	A55DTA143XST
Q5	TRANSISTOR	A55C1740STPQ
Q6	TRANSISTOR	A55DTC143XST
Q7	TRANSISTOR	A55DTA143TST
Q8	TRANSISTOR	A5520CVL33A
RY-FM	RELAY	A00161
RY-PWR	RELAY	A001001
SSR1	SSR	A56S26MD01M
T1	TRANSFORMER	A40367
VR1	VARISTOR	A44EVMEASB22
VR2	VARISTOR	A44VMEASB13
X1	RESONATOR	A45ST12MTWOT
ZD1	ZENAR DIODE	A54D6.2EB1TB
ZNR1	ZNR	ERZVA9V271
CR1, CR2	SURGE ABSORBER	A59014
FUSE HOLDER	FUSE HOLDER	XCSCW032

# 18 Electronic Circuit Diagram

- CS-G95KE
- CS-G125KE

## SCHEMATIC DIAGRAM 1/3

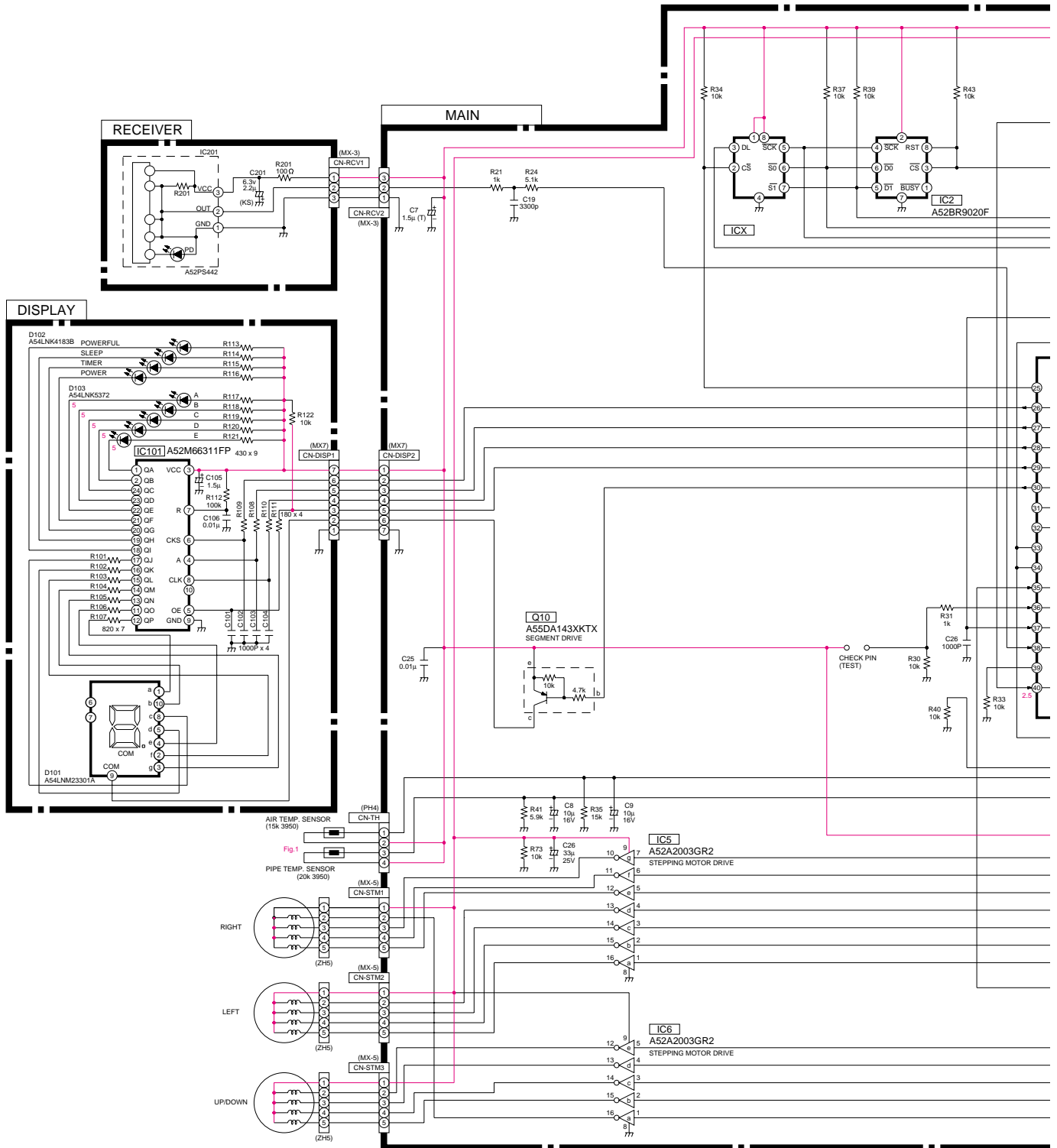

**SCHEMATIC DIAGRAM 2/3**

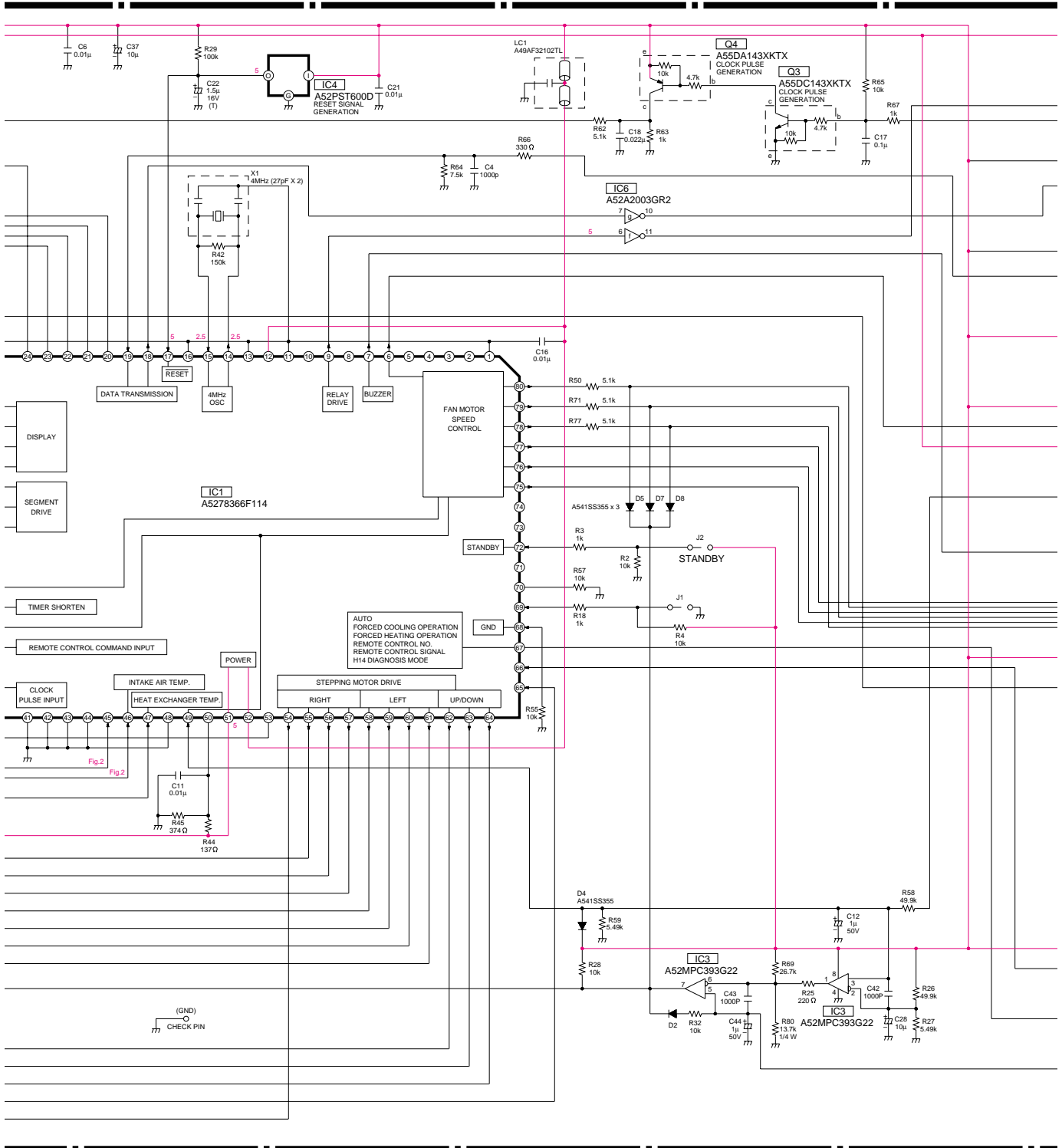



**SCHEMATIC DIAGRAM 3/3**

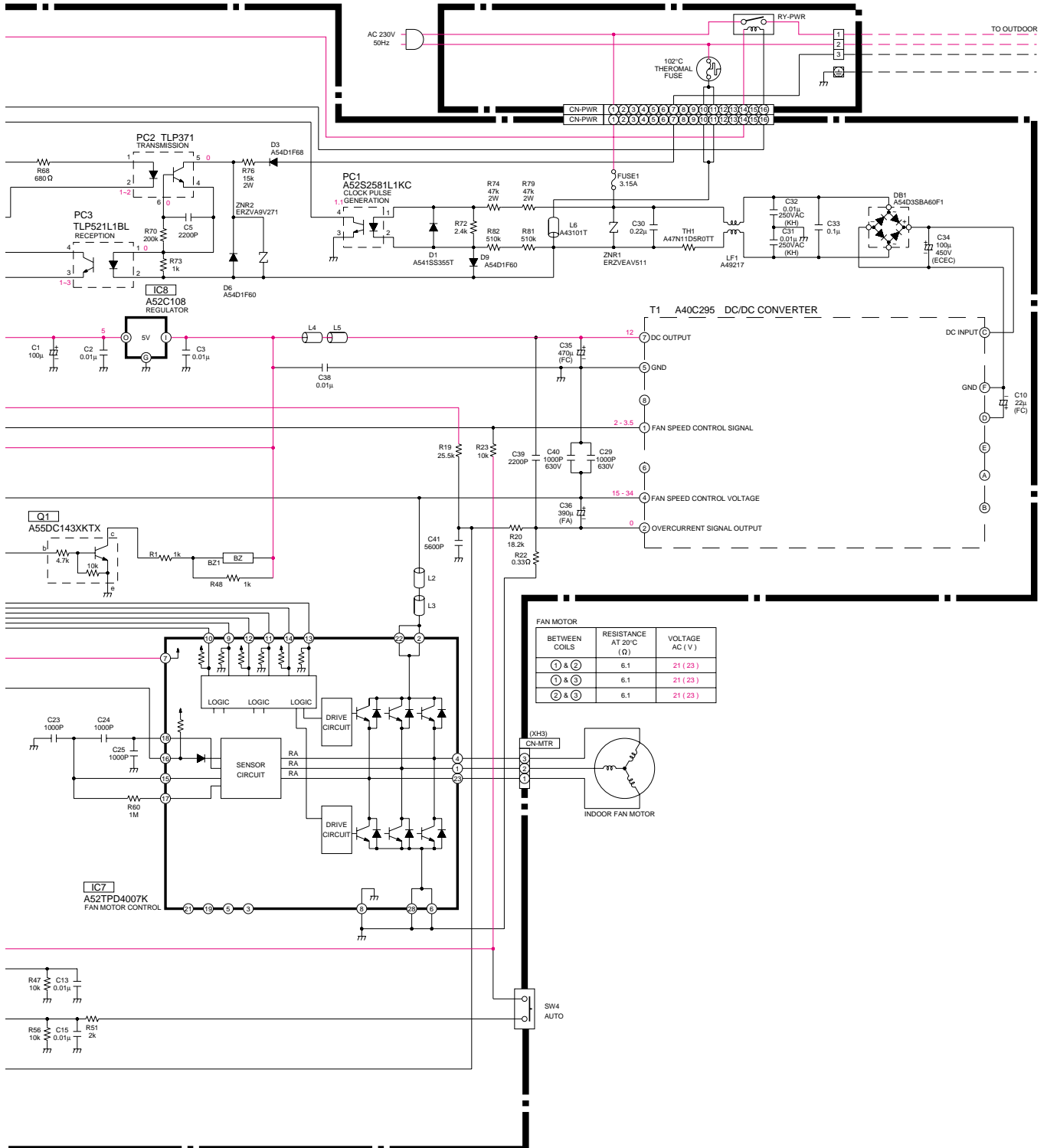

- CU-G95KE
- CU-G125KE

SCHEMATIC DIAGRAM 1/3

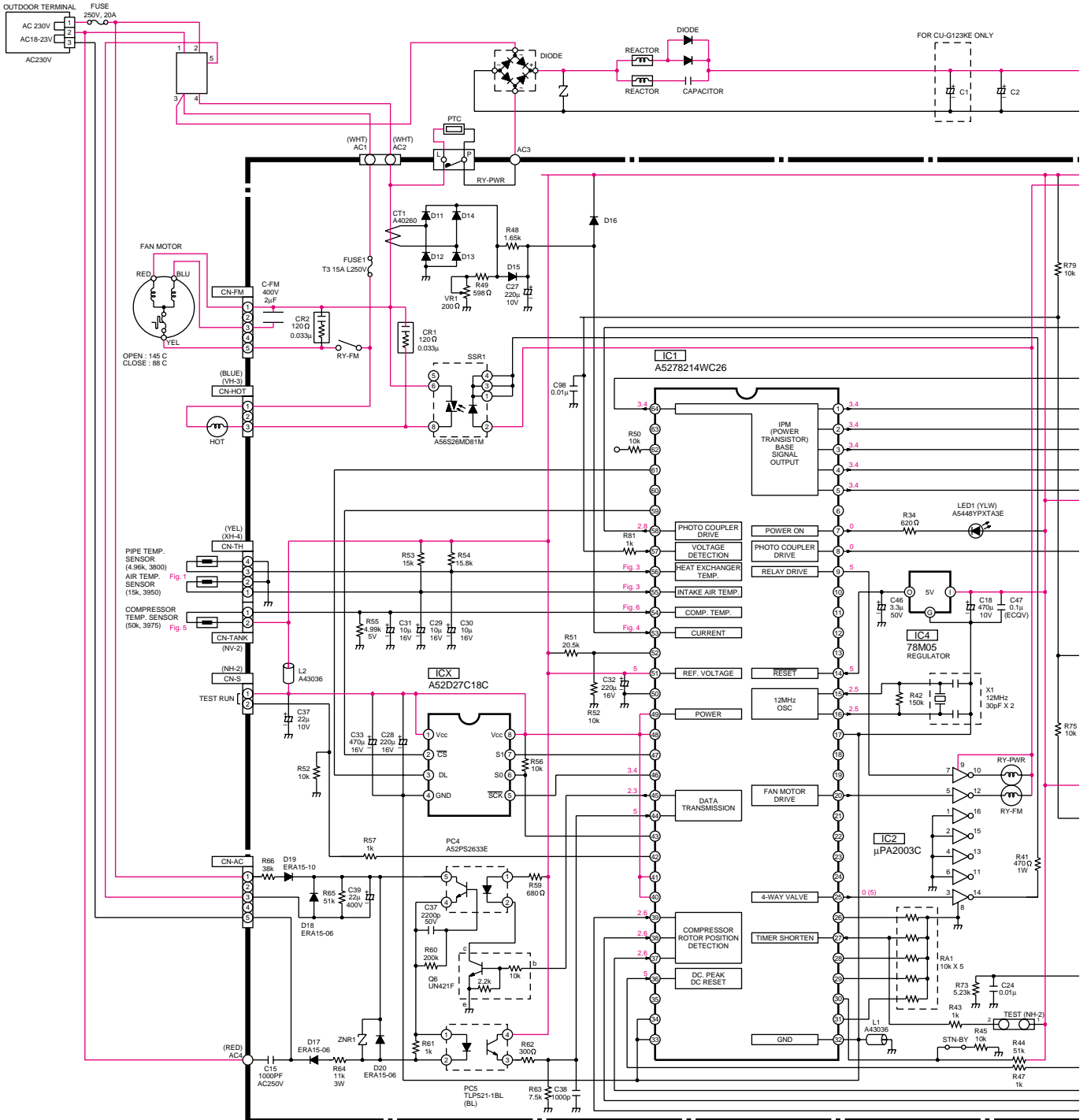

SCHEMATIC DIAGRAM 2/3

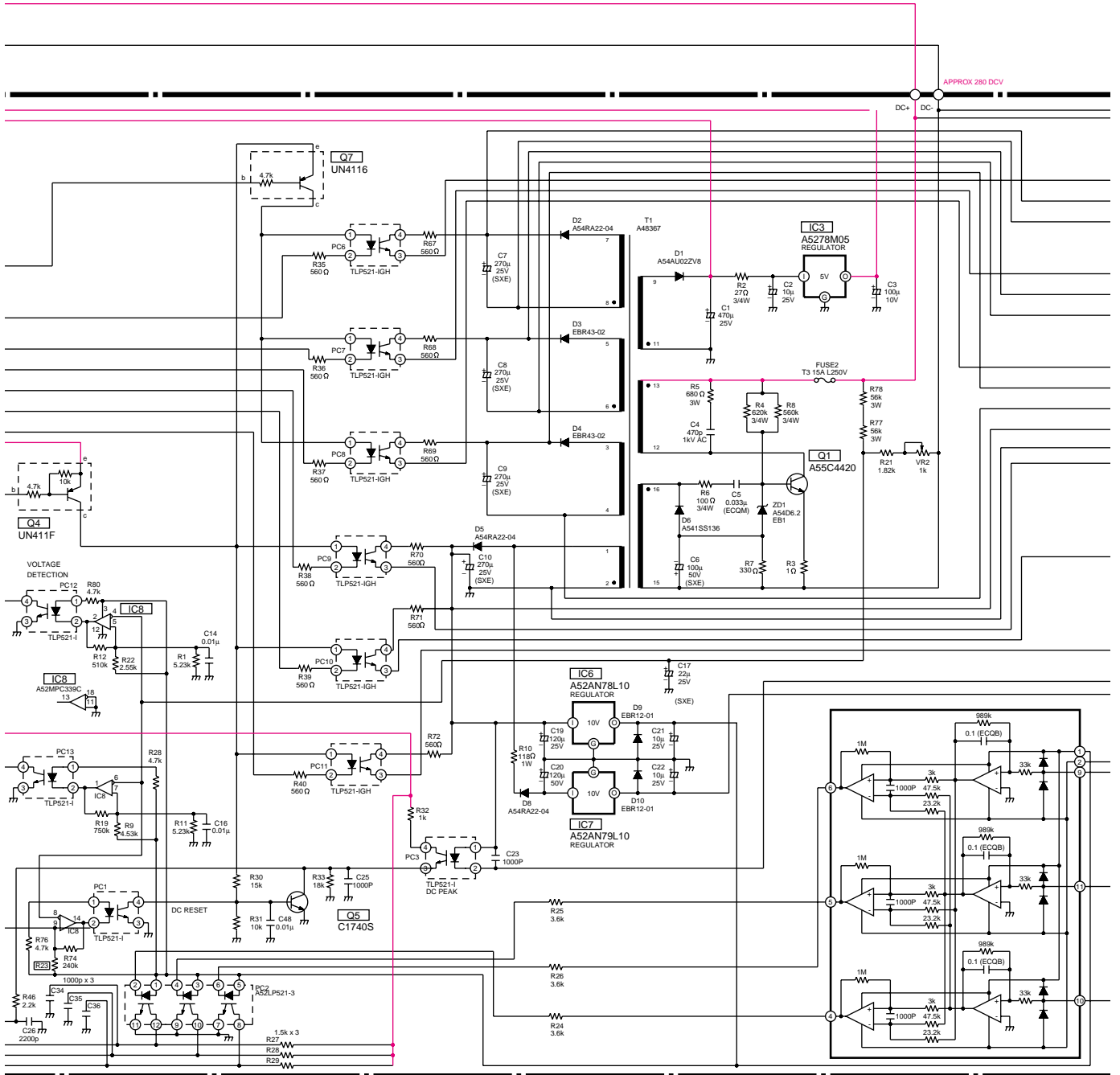

**SCHEMATIC DIAGRAM 3/3**

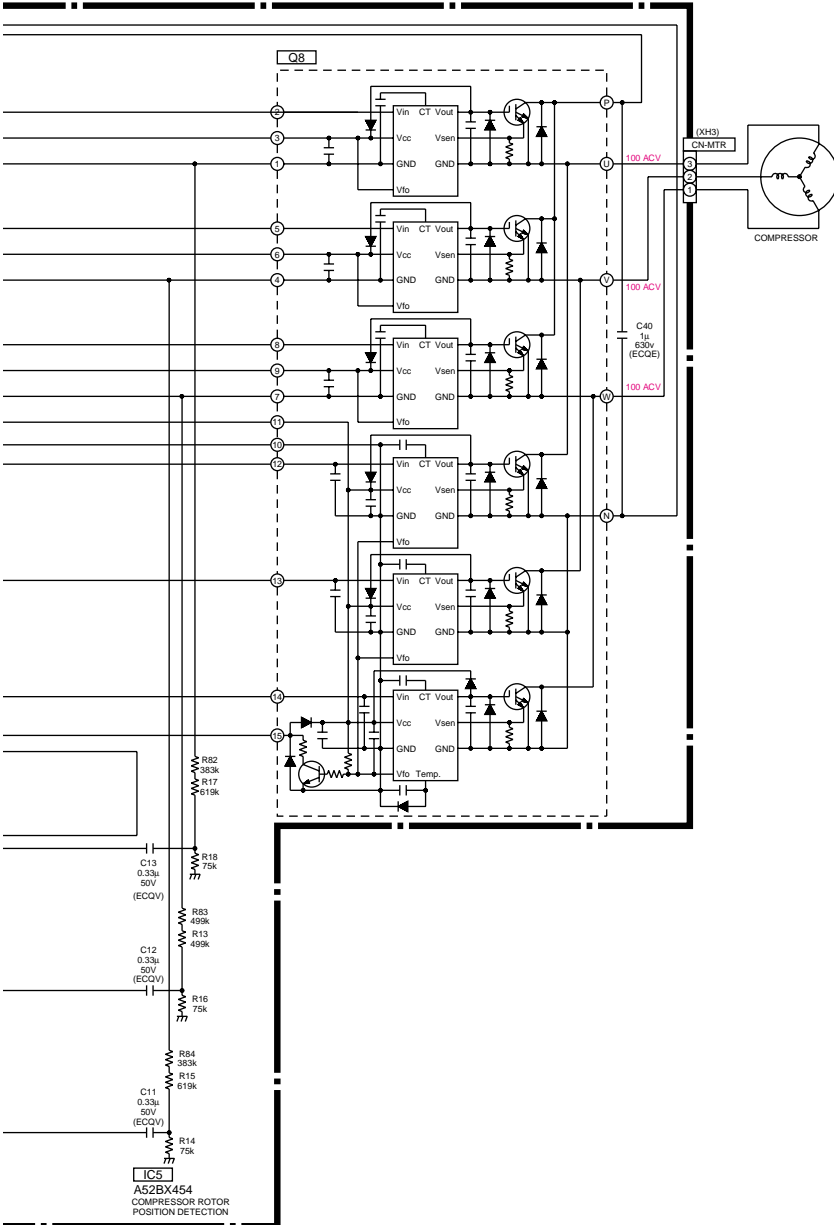

**CS-G95KE / CS-G125KE**

Fig. 1

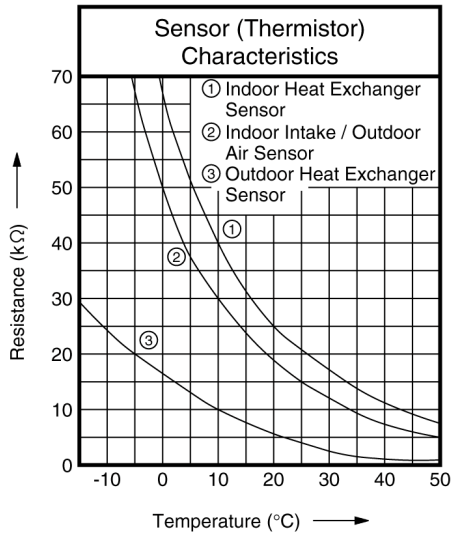
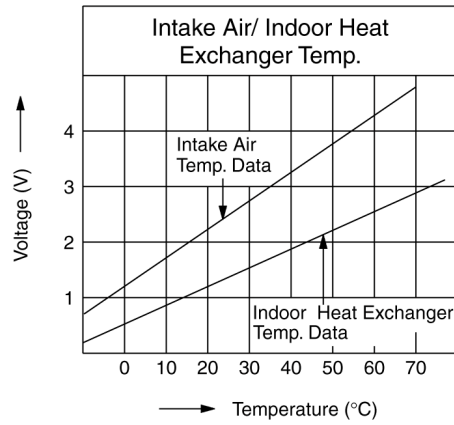

Fig. 2



**CU-G95KE / CU-G125KE**

Fig. 3

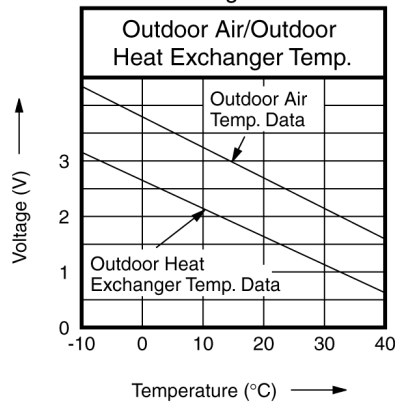

Fig. 4

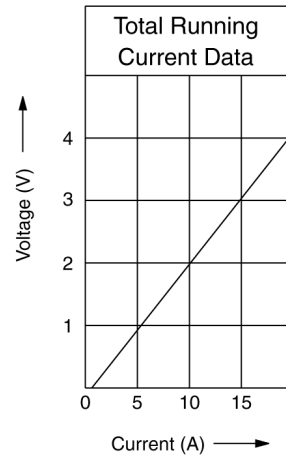

Fig. 5

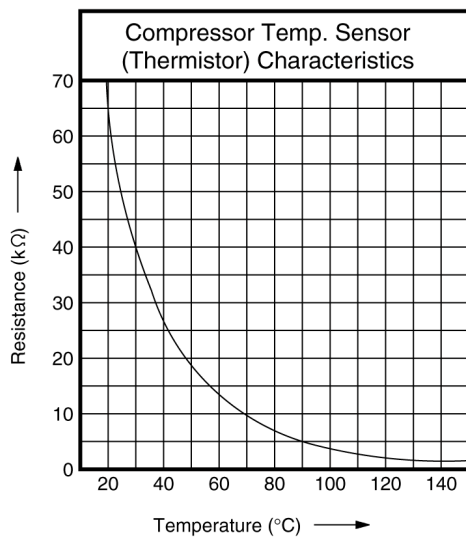
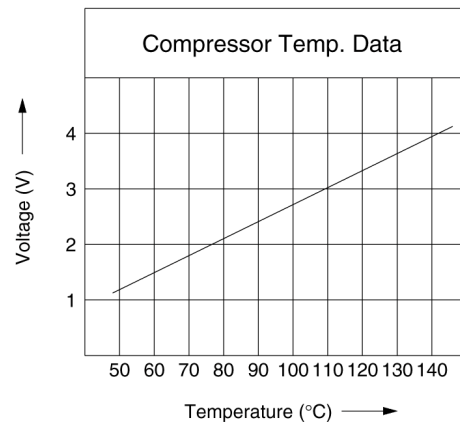

Fig. 6



## How to use electronic circuit diagram

Before using the circuit diagram, read the following carefully.

## \* Voltage measurement

Voltage has been measured with a digital tester when the indoor fan is set at high fan speed under the following conditions without setting the timer.

Use them for servicing.

Voltage indication is in Red at all operations.

## \* Indications for resistance

a. K....kΩ                      M....MΩ  
W...watt                      Not indicated....1/4W

## b. Type

Not indicated.....carbon resistor  
Tolerance±5%  
.....metal oxide resistor  
Tolerance±1%

## \* Indications for capacitor

a. Unit    μ....μF    P....pF  
b. Type    Not indicated....ceramic capacitor  
(S).....S series aluminium electrolytic capacitor  
(Z).....Z series aluminium electrolytic capacitor  
(SU).....SU series aluminium electrolytic capacitor  
(P).....P series polyester system  
(SXE).....SXE series aluminium electrolytic capacitor  
(SRA).....SRA series aluminium electrolytic capacitor  
(KME).....KME series aluminium electrolytic capacitor

\* Diode without indication.....MA165

※ Circuit Diagram is subject to change without notice for further development.

## TIMER TABLE &lt;INDOOR&gt;

Name	Time	Test mode (When test point Short-circuited)
4 Way Valve abnormality	4 min.	2.4 sec.
Outdoor air temp. for Hz No. decision	30 min.	0 sec.
Anti-dew formation control	20 min.	0 sec.
Anti-freezing control	6 min.	0 sec.
Themo OFF delay	3 min.	0 sec.
Low pressure control (gas leakage) compressor OFF time	3 min.	0 sec.
Time delay safety control	2 min. 58 sec.	0 sec.
Outdoor timer status shift time	30 sec.	0 sec.
	60 sec.	
Intake air temp. sampling time	20 sec.	0 sec.
Auto mode judgement sampling time	1 hr.	6 sec.
24 hours ON / OFF timer		1 hour → 1 min.
Heating SSHi fan speed shift	120 min.	12 sec.
Cooling SHi fan speed shift	30 min.	3 sec.
Hot start forced completion	4 min.	0 sec.
Outdoor timer status shift time	30 min.	3 sec.
	90 min.	9 sec.
	180 min.	18 sec.
	4200 min.	42 sec.
Auto mode judgement interval	30 min.	3 sec.
Sleep mode timer shift		1 hour → 6 sec.
After Hot start / Deice	2 min.	12 sec.

## TIMER TABLE &lt;OUTDOOR&gt;

Name	Time	Test mode (When test point Short-circuited)
DC PEAK	30 sec.	3 sec.
Deice detection	120 min.	24 sec.
	80 min.	16 sec.
	40 min.	8 sec.
	40 min.	8 sec.
Deice forced completion	11 min.	66 sec.
Hz lock time	30 sec.	0 sec.
Outdoor fan delay operation control	30 sec.	3 sec.
4 way valve delay operation control	3 min.	18 sec.

# 18.1. PRINT PATTERN INDOOR UNIT PRINTED CIRCUIT BOARD

## ● MAIN

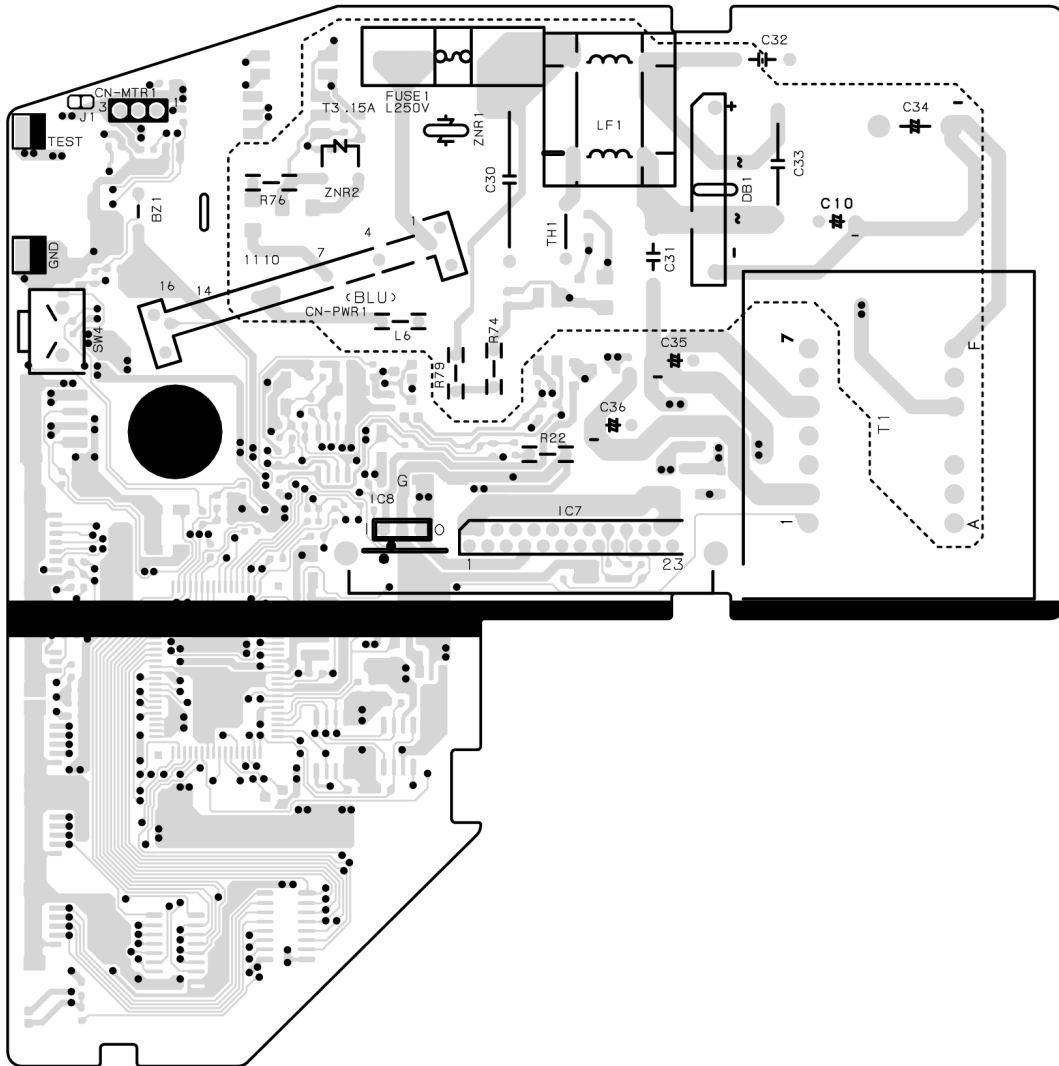

## ● INDICATOR

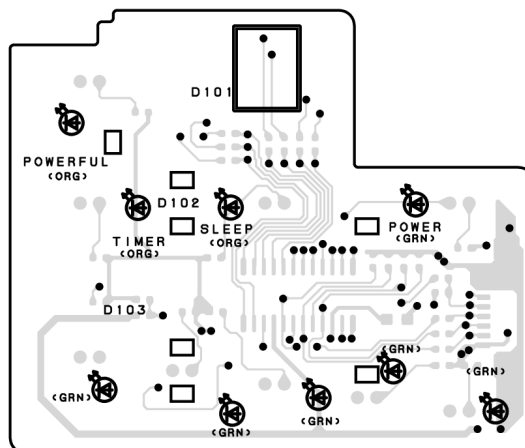



# 18.2. PRINT PATTERN OUTDOOR UNIT PRINTED CIRCUIT BOARDBOTTOM VIEW

- MAIN

